

Recommended P.C.B. Layout

SPECIFICATION
 Current Rating:1.5 Amp
 Withstand Voltage:500V AC
 Contact Resistance:20 Milliohms Max.
 Insulation Resistance:1000 Megaohms Min.
 Operation Temperature:-40°C~+105°C
 Insulator:PA6T(UL94V-0),Black
 Contact:Brass,Gold Plated Over Nickel
 RoHS Compliant

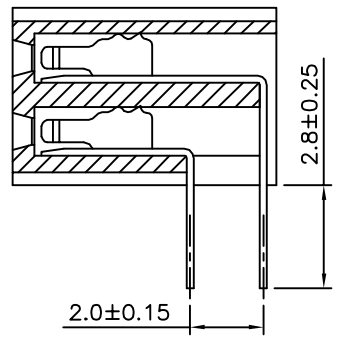
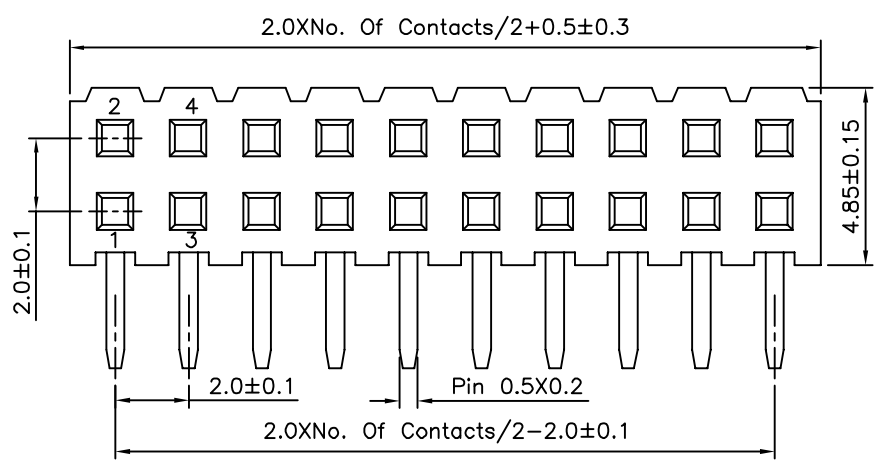
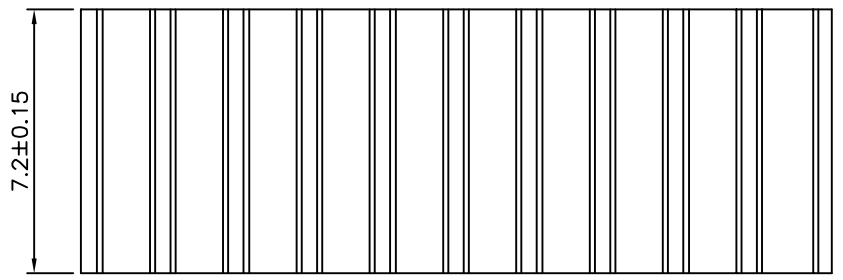

4UCON 元化興業股份有限公司
 4UCON TECHNOLOGY INC.

| | | | | |
|-------------|------|-------------|----|--|
| DRAWING No. | | APPROVED BY | | UNLESS OTHERWISE SPECIFIED TOLERANCES ARE >80 ±1.20 25~80 ±0.15 5~25 ±0.10 <5 ±0.05 ANG. ±0.03° |
| 00380 | | EMILY | | |
| | | CHECKED BY | | |
| | | HZF | | |
| | | DRAWING BY | | |
| | | GAO | | |
| SCALE | NONE | REV. | A0 | UNIT |
| | | | | mm |

| | | | | |
|------|------|-------------|-----|------------|
| NO. | REV. | REVISIONS | CHK | DATE |
| △ A0 | | NEW RELEASE | HZF | 12/25/2012 |