

**△ SPECIFICATION**  
 Current:3A  
 Operation Temperature:-55°C~+105°C  
 Contact Resistance:20 Milliohms Max.  
 Insulation Resistance:1000 Megaohms Min.  
 Withstanding Voltage:1000V AC RMS  
 Housing:PBT(UL94V-0),Black  
 Contact:Copper Alloy,Gold Flash  
 RoHS Compliant

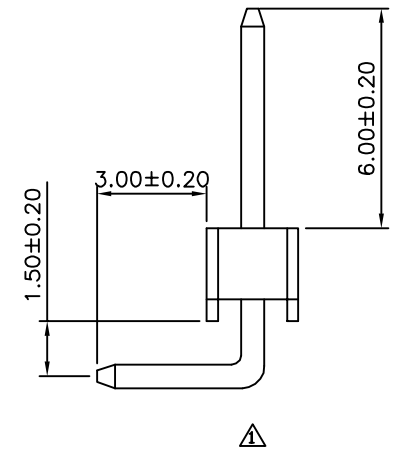
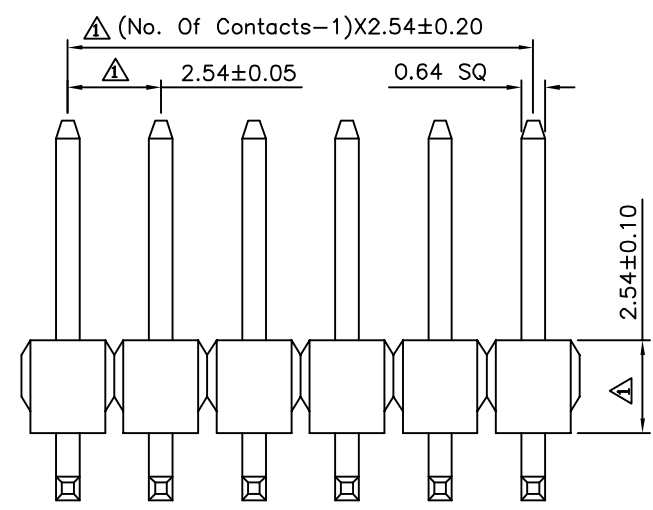
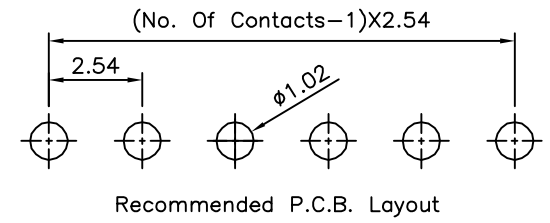
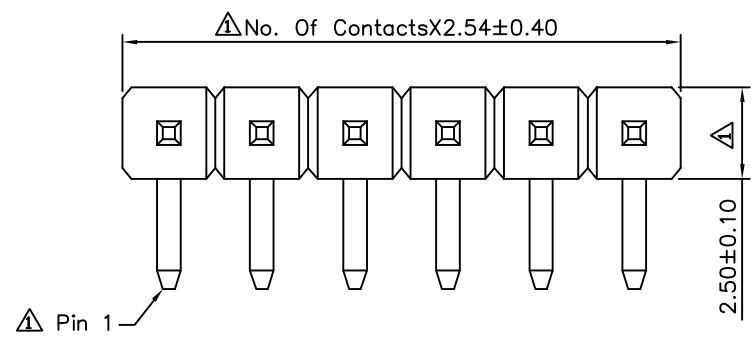

**4UCON** 元化興業股份有限公司  
 4UCON TECHNOLOGY INC.

DRAWING No.		APPROVED BY		UNLESS OTHERWISE SPECIFIED TOLERANCES ARE .X ±0.38 .XX ±0.25 ANG. ±5°
00892		MEI		
		CHECKED BY		
		HZF		
		DRAWING BY		
		QQJ		
SCALE	NONE	REV.	A1	UNIT
				mm

NO.	REV.	REVISIONS	CHK	DATE
△ A1		Modify Data	HZF	06/22/2010
△ A0		NEW RELEASE	SHIN	03/06/2006