

△ Recommended P.C.B. Layout

SPECIFICATION

- △ Current Rating:7A AC/DC
- Voltage Rating:250V AC Max.
- Operating Temperature:-25°C~+85°C
- Insulation Resistance:1000 Megaohms Min.
- Contact Resistance:10 Milliohms Max.
- △ Insulator:PA66(UL94V-0)
- △ Terminal:Brass,Tin Plated Over Nickel
- RoHS Compliant

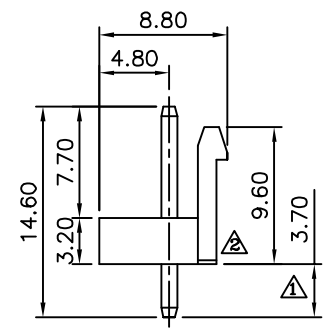
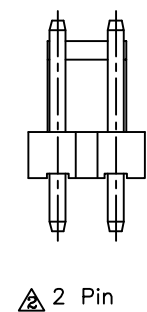
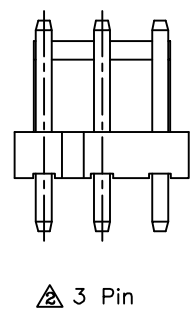
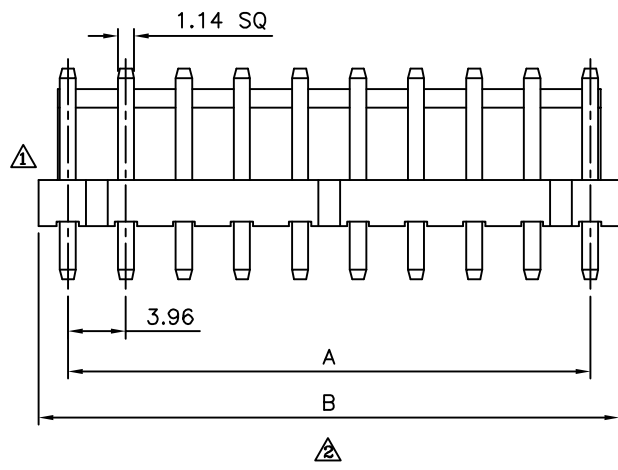
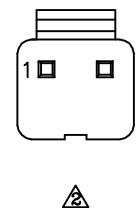
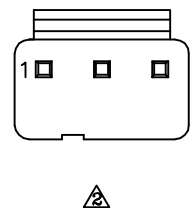
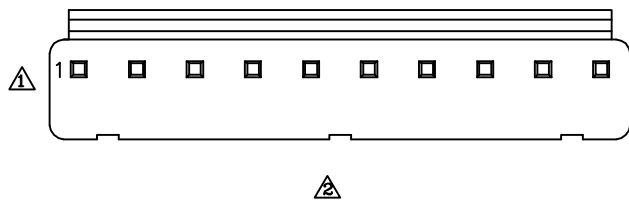

Pin	A	B
02	3.96	7.92
03	7.92	11.92
04	11.88	15.84
05	15.84	19.84
06	19.80	23.80
07	23.76	27.88
08	27.72	31.74
09	31.68	35.86
10	35.64	39.90
11	39.60	43.84
12	43.56	47.92
13	47.52	51.72
14	51.48	55.92

4UCON 元化興業股份有限公司
4UCON TECHNOLOGY INC.

DRAWING No.		APPROVED BY		UNLESS OTHERWISE SPECIFIED TOLERANCES ARE .X ±0.5 .XX ±0.35 ANG.	△ B3 Modify Data HZF 03/13/2015 △ B2 Modify Data HZF 01/03/2013 △ B1 Modify Data HZF 09/15/2009 △ B0 NEW RELEASE BECKY 11/14/2005		
02198		MEI					
		CHECKED BY HZF					
		DRAWING BY HAO					
SCALE	NONE	REV.	B3	UNIT	mm		
				NO.REV.	REVISIONS	CHK	DATE