

△ Recommended P.C.B. Layout

**SPECIFICATION**

- △ Current Rating:7A AC/DC
- Voltage Rating:250V AC Max.
- Operating Temperature:-25°C~+85°C
- Insulation Resistance:1000 Megaohms Min.
- Contact Resistance:10 Milliohms Max.
- △ Insulator:PA66(UL94V-0)
- △ Terminal:Brass,Tin Plated Over Nickel
- RoHS Compliant

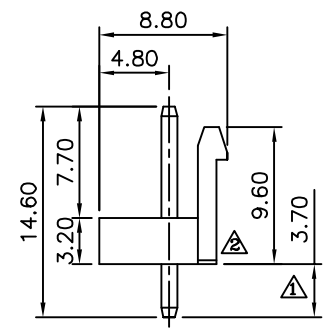
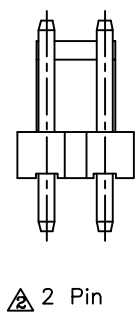
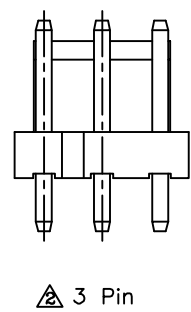
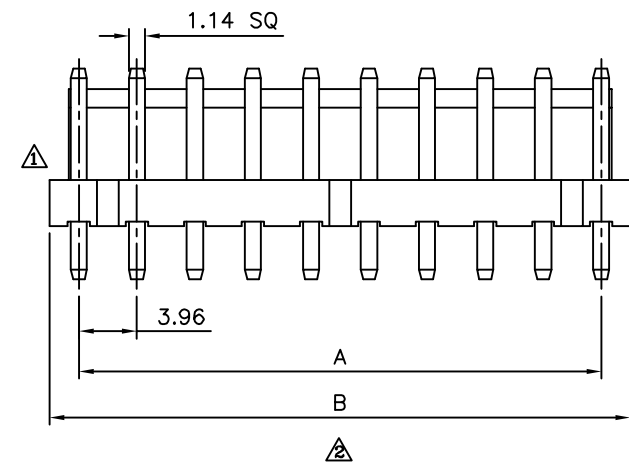
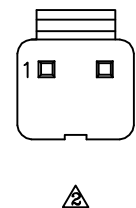
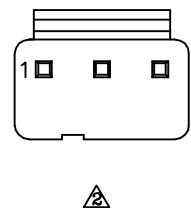
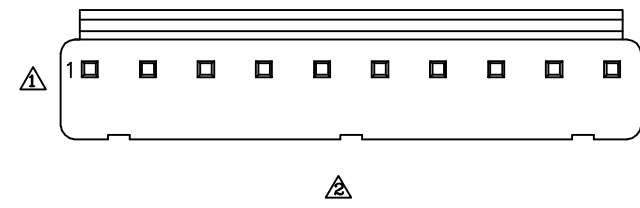

| Pin | A     | B     |
|-----|-------|-------|
| 02  | 3.96  | 7.92  |
| 03  | 7.92  | 11.92 |
| 04  | 11.88 | 15.84 |
| 05  | 15.84 | 19.84 |
| 06  | 19.80 | 23.80 |
| 07  | 23.76 | 27.88 |
| 08  | 27.72 | 31.74 |
| 09  | 31.68 | 35.86 |
| 10  | 35.64 | 39.90 |
| 11  | 39.60 | 43.84 |
| 12  | 43.56 | 47.92 |
| 13  | 47.52 | 51.72 |
| 14  | 51.48 | 55.92 |

**4UCON** 元化興業股份有限公司  
4UCON TECHNOLOGY INC.

|             |      |             |    |   |  |     |      |
|-------------|------|-------------|----|---|--|-----|------|
| DRAWING No. |      | APPROVED BY |    | UNLESS OTHERWISE SPECIFIED TOLERANCES ARE<br>.X ±0.5<br>.XX ±0.35<br>ANG. | △ B3 Modify Data HZF 03/13/2015<br>△ B2 Modify Data HZF 01/03/2013<br>△ B1 Modify Data HZF 09/15/2009<br>△ B0 NEW RELEASE BECKY 11/14/2005 |     |      |
| 02199       |      | MEI         |    |   |  |     |      |
|             |      | HZF         |    |   |  |     |      |
|             |      | HAO         |    |   |  |     |      |
| SCALE       | NONE | REV.        | B3 | UNIT  | mm   |     |      |
|             |      |             |    |   |  |     |      |
|             |      |             |    | NO.REV.   | REVISIONS  | CHK | DATE |