

SPECIFICATIONS
 Material: Nylon66
 UL 94V-2

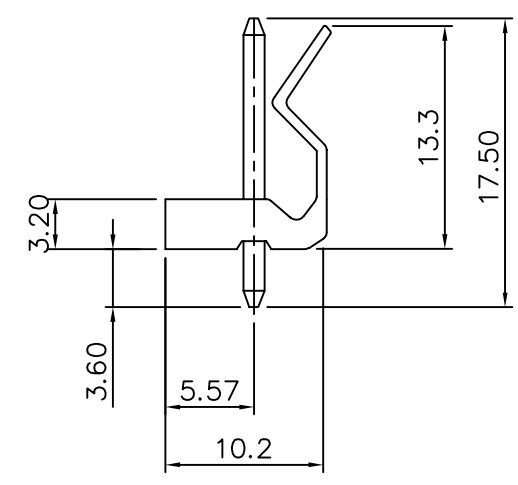
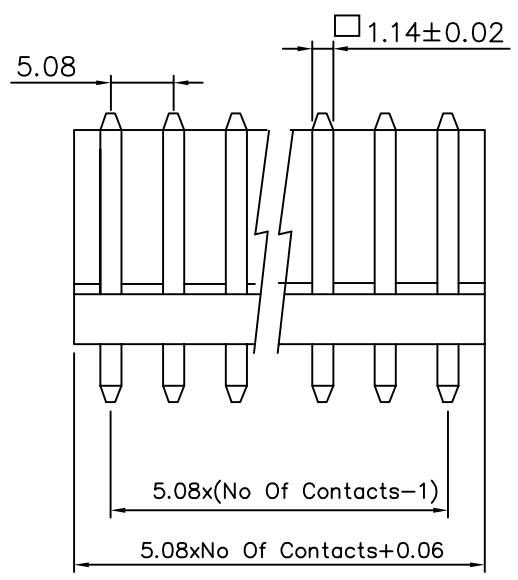

4UCON 元化興業股份有限公司
 4UCON TECHNOLOGY INC.

DRAWING No.		APPROVED BY		UNLESS OTHERWISE SPECIFIED TOLERANCES ARE .X ±0.38 .XX ±0.25 ANG.
02405		MEI		
		RAN		
		DRAWING BY		
		HZF		
SCALE	NONE	REV.	A	UNIT mm

AREA	REVISIONS	CHK	DATE