

SPECIFICATION

Voltage Rating: 250V(AC)
 Current Rating: 5A
 Contact Resistance: 20 Milliohms Max.
 Dielectric Withstanding Voltage: 1000V AC/1min.
 Insulation Resistance: 1000 Megaohms Min.
 Circuits: 2~20
 Insulator: Nylon 66 UL 94V-2
 Color: Natural
 Contact: Brass 1.14mm Square Wire Pins
 Plating: Tin or Gold Plated
 Temperature Range: -25°C to +85°C
 RoHS Compliant

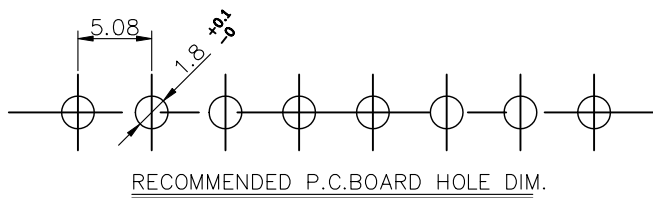
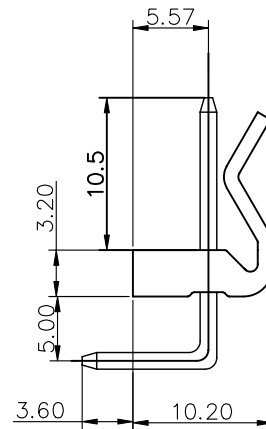
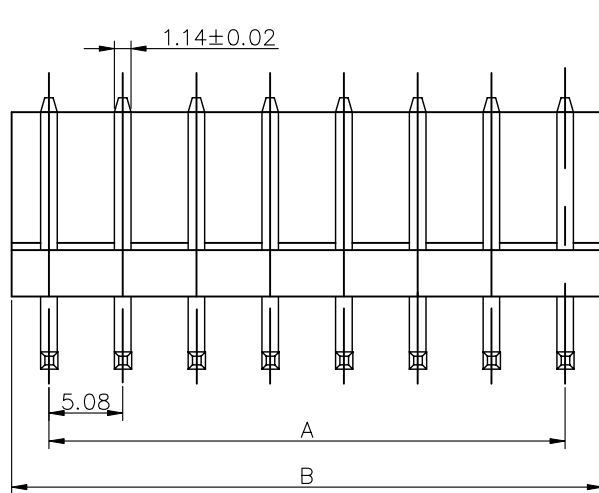

Poles	Dimension	
	A	B
2	5.08	10.22
3	10.16	15.30
4	15.24	20.38
5	20.32	25.46
6	25.40	30.54
7	30.48	35.62
8	35.56	40.70
9	40.64	45.78
10	45.72	50.86

4UCON 元化興業股份有限公司
4UCON TECHNOLOGY INC.

DRAWING No.

02415

APPROVED BY

MEI

CHECKED BY

BECKY

DRAWING BY

LCH

UNLESS OTHERWISE SPECIFIED TOLERANCES ARE

.X ±0.5

.XX ±0.3

ANG.

SCALE

NONE

REV.

A0

UNIT

mm



NO. REV.

A0 NEW RELEASE

REVISIONS

CHK

DATE