

SPECIFICATION
 Current Rating:12A AC/DC
 Voltage Rating:300V AC/DC
 Withstanding Voltage:1500V AC/Minute
 Insulation Resistance:1000 Megaohms Min.
 Temperature Range:-25°C~+90°C
 Material:PA66(UL94V-2)
 RoHS Compliant

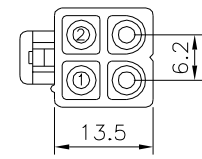
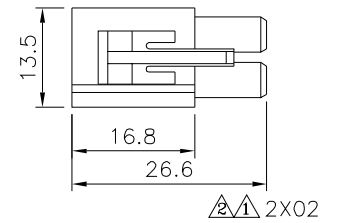
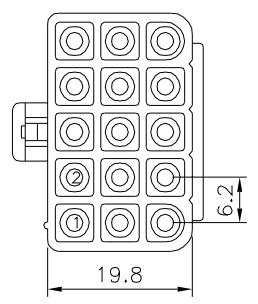
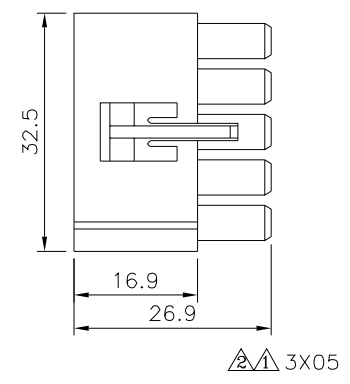
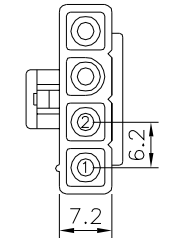
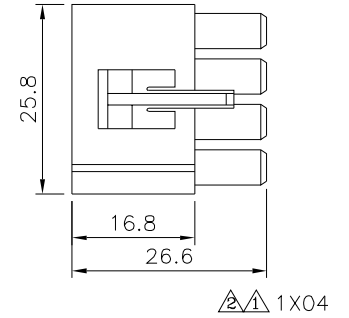
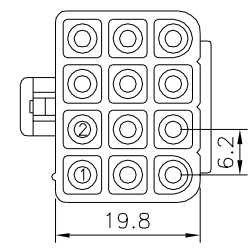
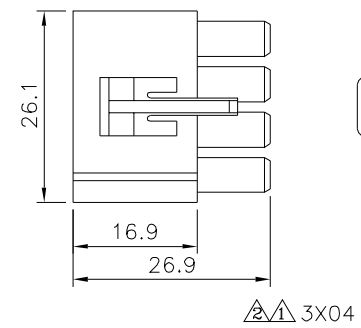
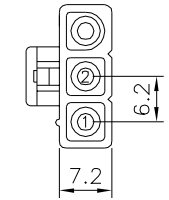
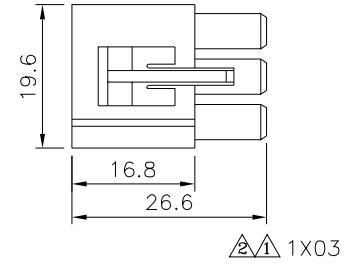
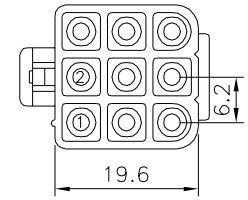
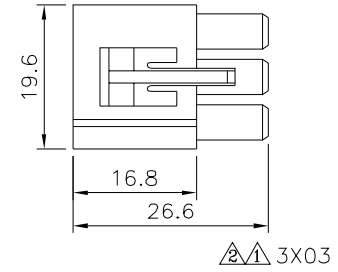
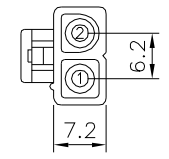
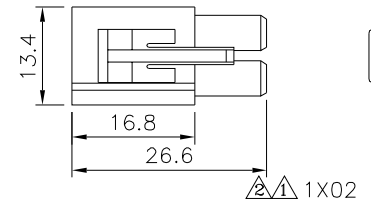
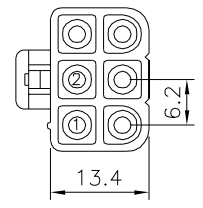
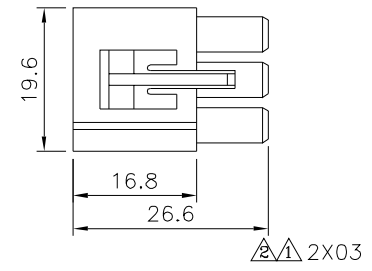
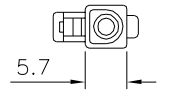
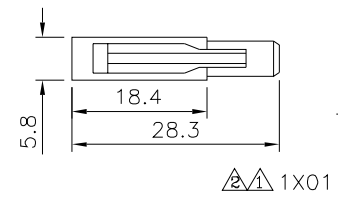

4UCON 元化興業股份有限公司
 4UCON TECHNOLOGY INC.

DRAWING No.		APPROVED BY		UNLESS OTHERWISE SPECIFIED TOLERANCES ARE
02436		EMILY		
		CHECKED BY		
		HZF		
		DRAWING BY		.X ±0.3
		SONG		
SCALE	NONE	REV.	A2	UNIT
				mm

NO.	REV.	REVISIONS	CHK	DATE
△	A2	Modify Data	HZF	05/05/2014
△	A1	Modify Data	HZF	03/15/2011
△	A0	NEW RELEASE	BECKY	09/16/2005