

SPECIFICATION
 Current Rating:12A AC,DC
 Voltage Rating:600V AC,DC
 Withstanding Voltage:1500V AC/Minute
 Insulation Resistance:1000 Megaohms Min.
 Temperature Range:-25°C~+90°C
 Material:PA66(UL94V-2)
 RoHS Compliant

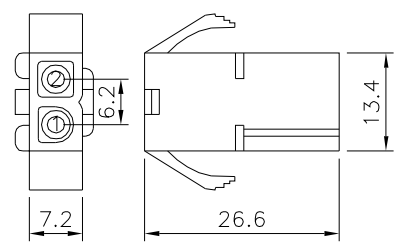

1X02

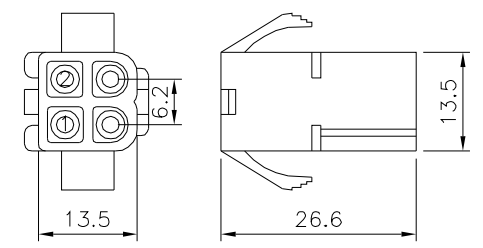

2X02

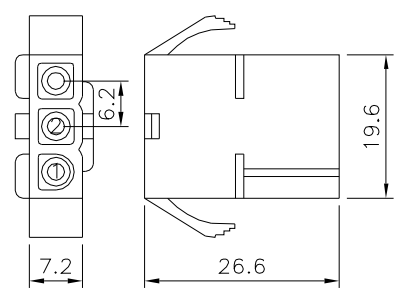

1X03

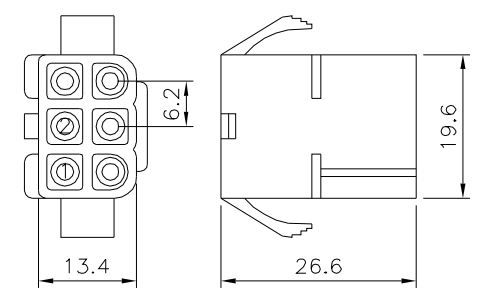

2X03

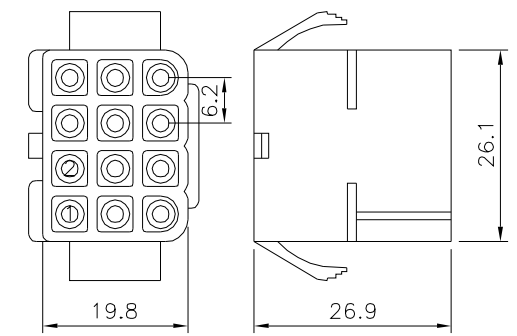

3X04

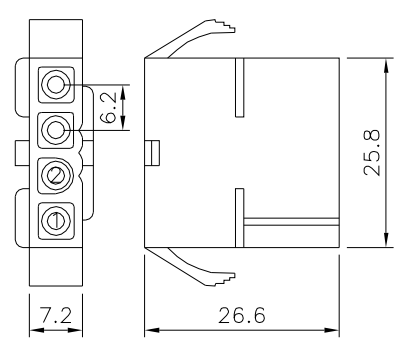

1X04

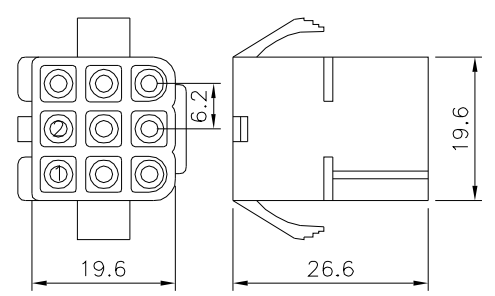

3X03

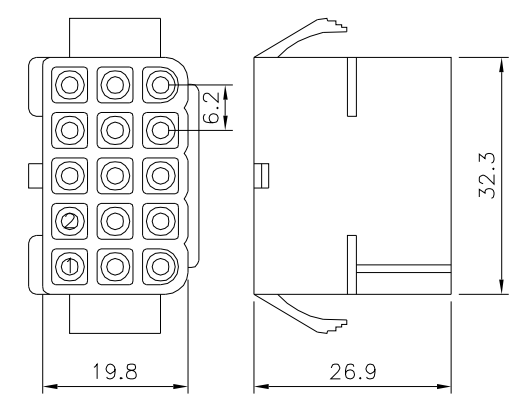

3X05

4UCON 元化興業股份有限公司
 4UCON TECHNOLOGY INC.

DRAWING No.		APPROVED BY		UNLESS OTHERWISE SPECIFIED TOLERANCES ARE .X ±0.3
02445		MEI		
		CHECKED BY HZF		
DRAWING BY		YBL		
SCALE	NONE	REV.	A2	UNIT mm

NO.	REV.	REVISIONS	CHK	DATE
△2	A2	Modify Data	HZF	02/21/2014
△1	A1	Modify Data	HZF	03/15/2011
△0	A0	NEW RELEASE	BECKY	09/16/2005