

Recommended P.C.B. Layout

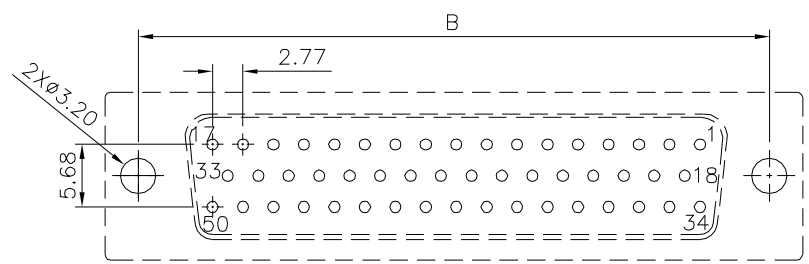

Recommended P.C.B. Layout

△ SPECIFICATION
 Current Rating:1A Max.
 Dielectric Withstanding Voltage:500V AC
 For 1 Minute
 Contact Resistance:30 Milliohms Max.
 Insulation Resistance:1000 Megaohms Min.
 At DC 500V
 Temperature Range:-55°C~+105°C
 RoHS Compliant

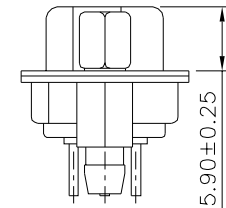
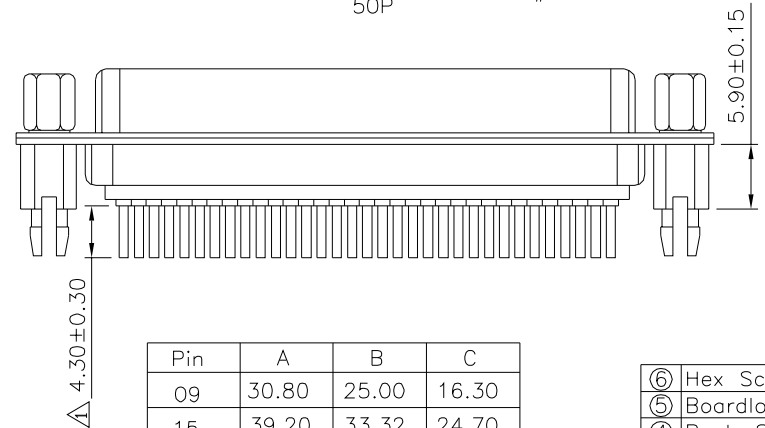
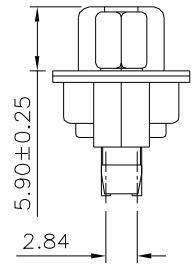
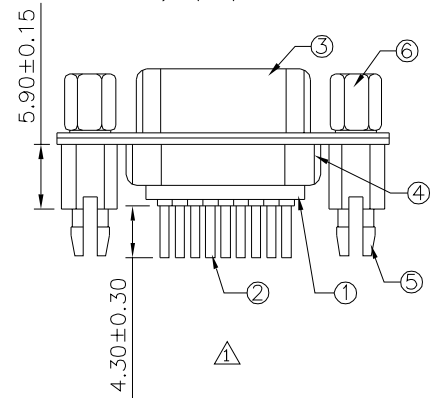
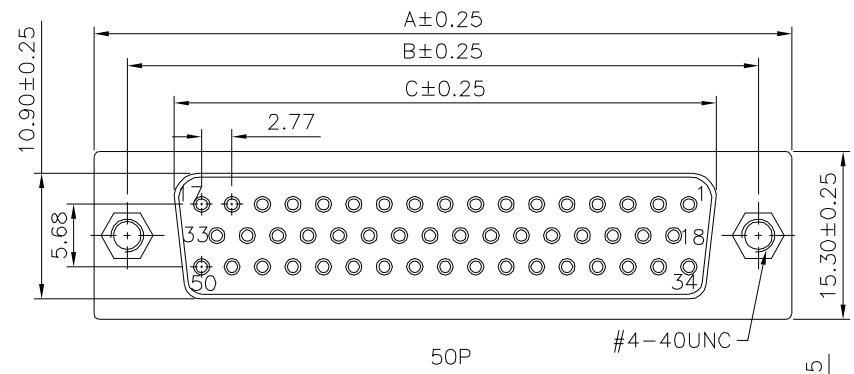
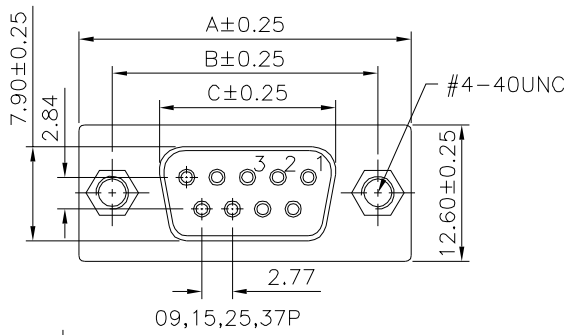

Pin	A	B	C
09	30.80	25.00	16.30
15	39.20	33.32	24.70
25	53.05	47.04	38.40
37	69.40	63.50	54.80
50	67.10	61.00	52.20

No.	Description	Q'ty	Material	Remark
⑥	Hex Screw	2	Brass	Nickel Plated
⑤	Boardlock	2	Brass	Tin Plated
④	Back-Shell	1	Cold Rolled Steel	Tin Plated
③	Front-Shell	1	Cold Rolled Steel	Tin Plated
②	Contact	2	Brass	Gold Plated Over Nickel
①	Housing	2	PBT,UL94V-0,White	

4UCON 元化興業股份有限公司
 4UCON TECHNOLOGY INC.

DRAWING No.		APPROVED BY		UNLESS OTHERWISE SPECIFIED TOLERANCES ARE .X ±0.30 .XX ±0.20 .XXX ±0.10 ANG. ±1°
02928		MEI		
		CHECKED BY HZF		
		DRAWING BY CYP		
SCALE	NONE	REV.	A1	UNIT mm

NO.	REV.	REVISIONS	CHK	DATE
△ A1		Modify Data	HZF	04/02/2015
△ A0		NEW RELEASE	HZF	03/18/2012