

**SPECIFICATION**

Rating: 2A 100V AC  
 Insulation Resistance: 100Megohm Min. At 500V DC  
 Dielectric Strength: 1000V AC/1 Minute  
 Contact Resistance: 20Milliohms Max

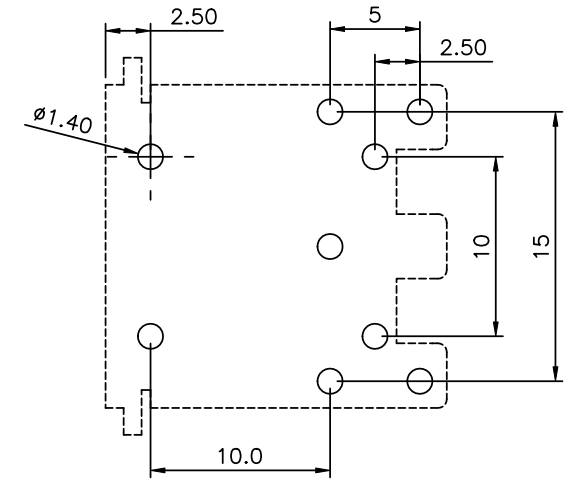
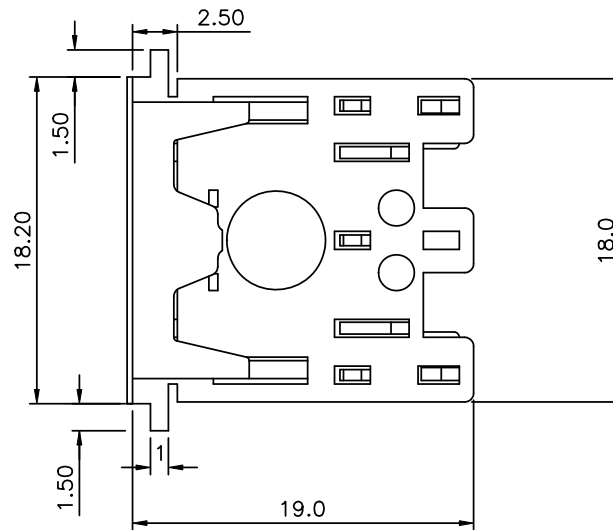
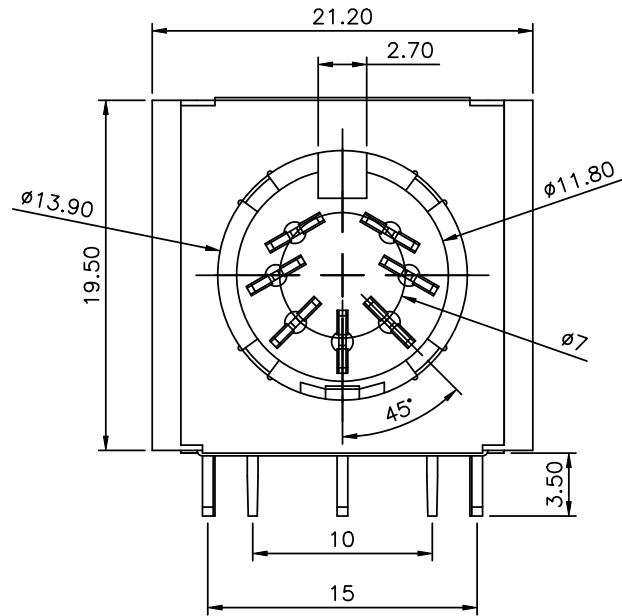

P.C.B Layout  
(Bottom View)

No.	Description	Material	Treat
1	Shell Cover	PBT	
2	Base	PBT	
3	Gnd	Copper	Nickel Plated
4	Shield Cover	Copper	Nickel Plated
5	Pin	Brass	Tin Plated

**4UCON** 元化興業股份有限公司  
 4UCON TECHNOLOGY INC.

DRAWING No.

05133

SCALE

NONE

APPROVED BY

MEI

CHECKED BY

HZF

DRAWING BY

LXX

REV.

A0

UNLESS OTHERWISE SPECIFIED TOLERANCES ARE

.X ±0.25

.XX ±0.10

ANG

UNIT

mm



△ A0

NEW RELEASE

HZF

09/25/2007

NO. REV.

REVISIONS

CHK

DATE