

△ SPECIFICATION

Rating:100V AC 1A Max.
 Insulation Resistance:50 Megaohms Min. At 500V DC
 Dielectric Strength:500V AC/1 Minute
 Insertion Force:4.5kg Max.
 Withdrawal Force:0.9kg~3kg
 Cover:EVA+PE(2L)
 Shell:ABS
 Metal Shield:Brass,Nickel Plated
 △ Housing:PA6+FB
 Contact:Brass,Silver Plated
 RoHS Compliant

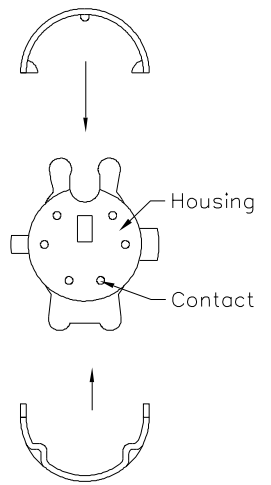
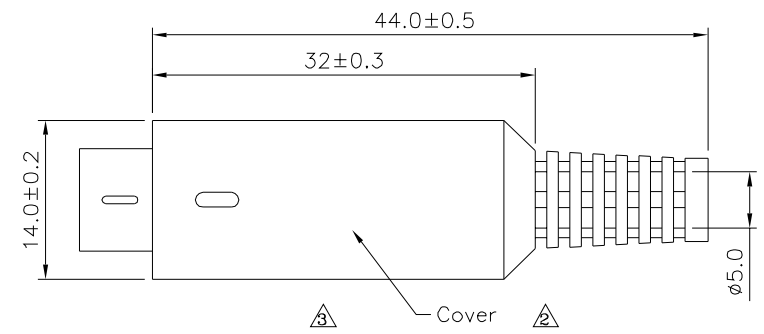
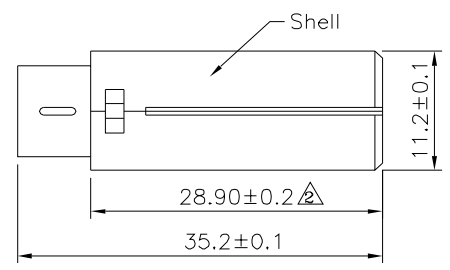
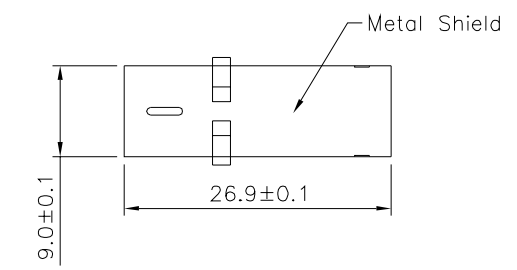

05187	05188	05190	05191	05193	05194

4UCON 元化興業股份有限公司
 4UCON TECHNOLOGY INC.

DRAWING No.		APPROVED BY		UNLESS OTHERWISE SPECIFIED TOLERANCES ARE .X ±0.20 △ .XX ±0.10 ANG.	△ B4	Modify Data	HZF	03/07/2018
05194		MEI			△ B3	Modify Data	HZF	08/10/2015
		CHECKED BY			△ B2	Modify Data	HZF	08/23/2013
SCALE NONE		DRAWING BY		△ B1	Add UL94V-0	HZF	11/23/2010	
		CYP		△ B0	NEW RELEASE	EMILY	09/17/2008	
REV.	B4	UNIT	mm	NO. REV. REVISIONS		CHK	DATE	