

**SPECIFICATION**

Current Rating:12A AC/DC  
 Voltage Rating:300V AC/DC  
 Withstanding Voltage:1500V AC/Minute  
 Insulation Resistance:1000 Megaohms Min.  
 Temperature Range:-25°C~+90°C  
 Material:PA66(UL94V-2)  
 RoHS Compliant

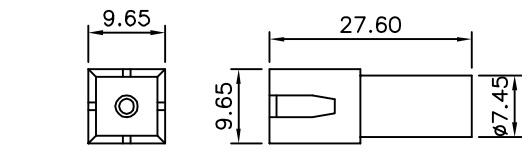

△1X01

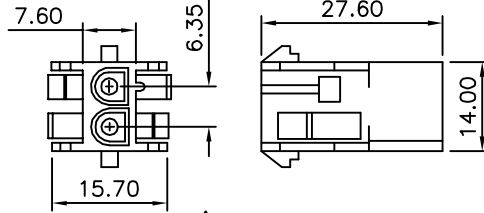

△1X02

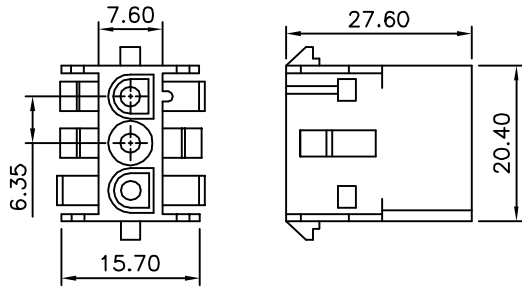

△1X03

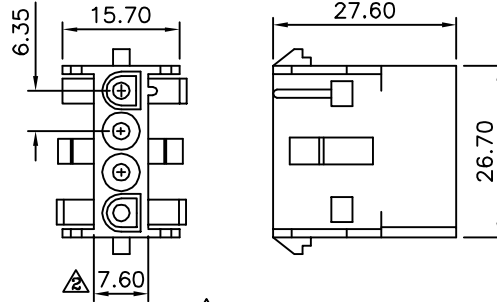

△1X04

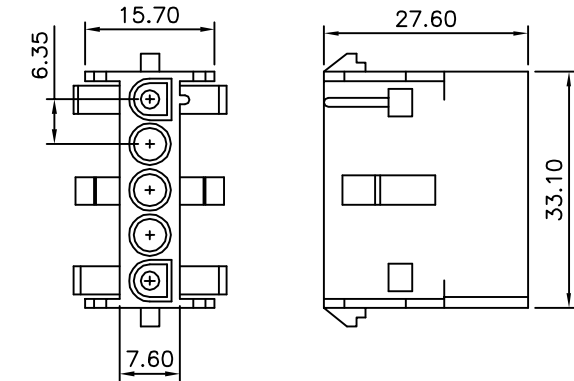

△1X05

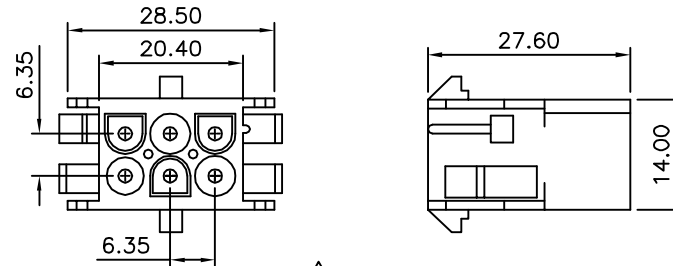

△2X03

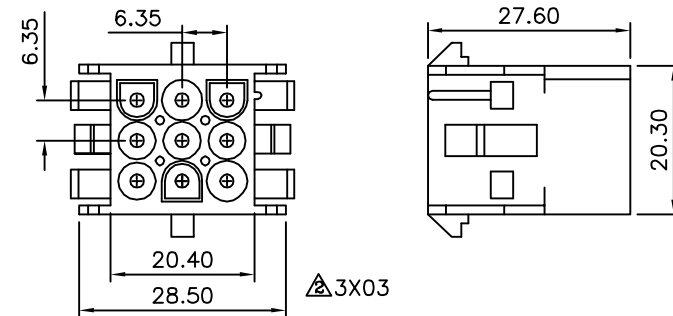

△3X03

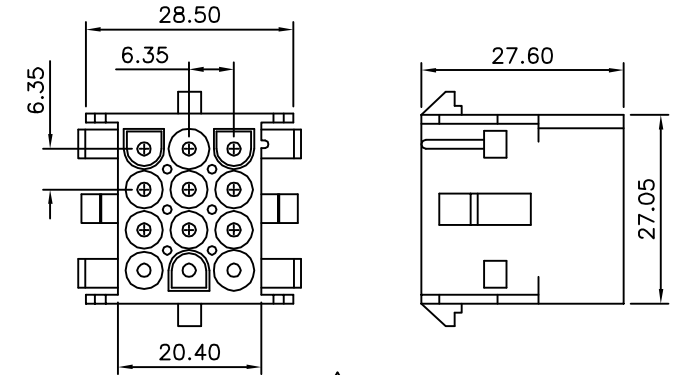

△3X04

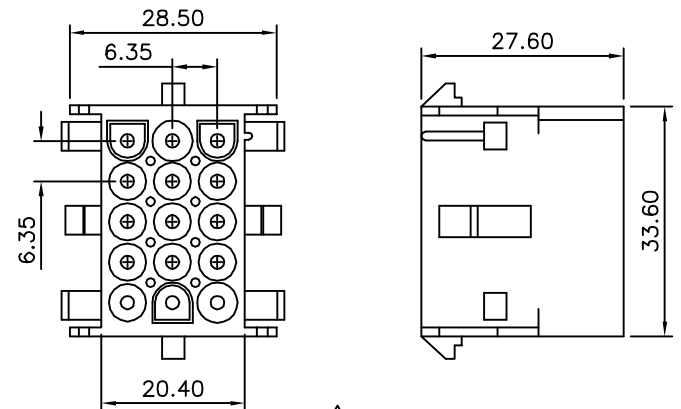

△3X05

**4UCON** 元化興業股份有限公司  
 4UCON TECHNOLOGY INC.

DRAWING No.

07042

APPROVED BY

MEI

CHECKED BY

HZF

DRAWING BY

SONG

REV. A2

UNLESS OTHERWISE SPECIFIED TOLERANCES ARE  
 .X ±0.3  
 .XX ±0.3  
 ANG.

UNIT mm



NO.	REV.	REVISIONS	CHK	DATE
△A2		Modify Data	HZF	11/09/2012
△A1		Modify Data	HZF	06/20/2011
△A0		NEW RELEASE		

SCALE

NONE

REV.

A2

UNIT

mm

NO.

REV.

REVISIONS

CHK

DATE