

SPECIFICATION

Current Rating:12A AC/DC
 Voltage Rating:300V AC/DC
 Withstanding Voltage:1500V AC/Minute
 Insulation Resistance:1000 Megaohms Min.
 Temperature Range:-25°C~+90°C
 Material:PA66(UL94V-2)
 RoHS Compliant

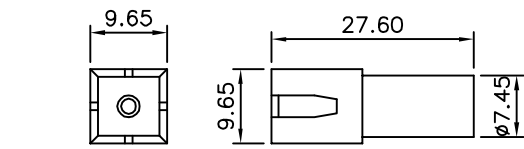

△1X01

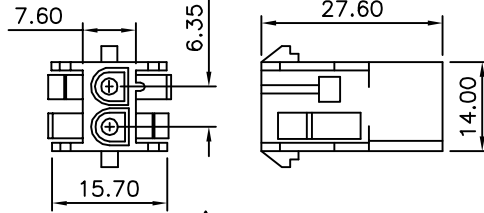

△1X02

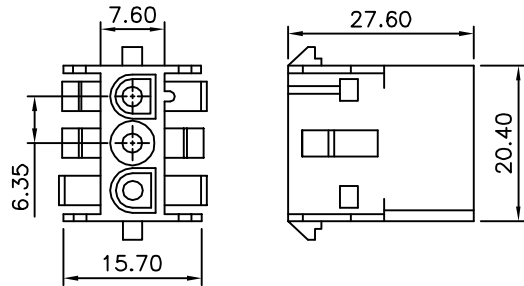

△1X03

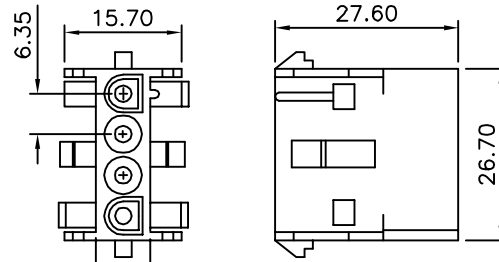

△1X04

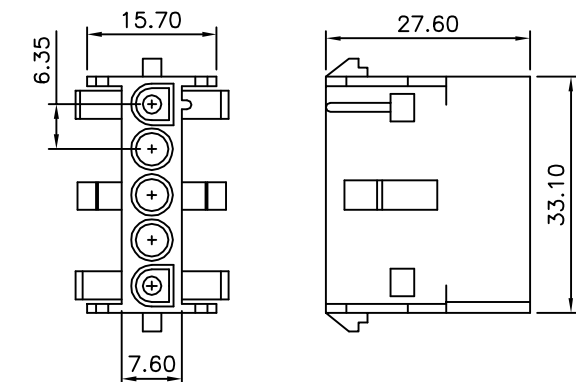

△1X05

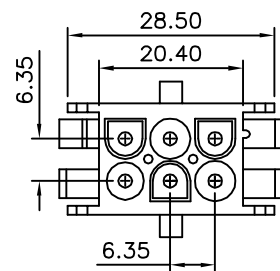

△2X03

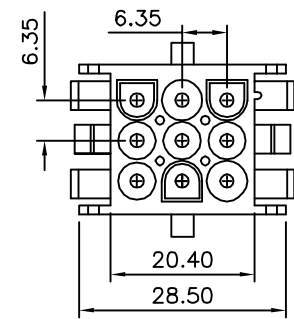
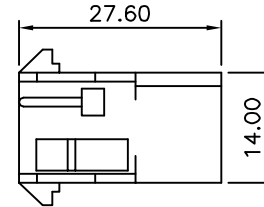

△3X03

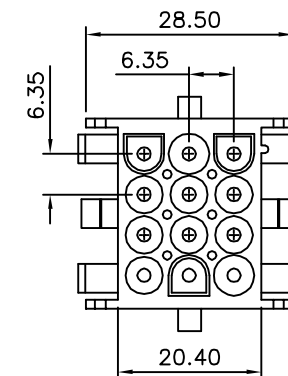
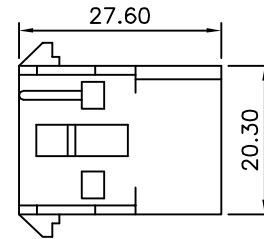

△3X04

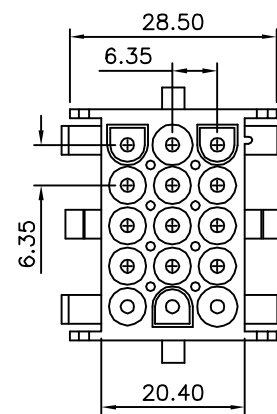
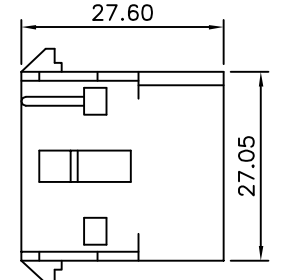

△3X05

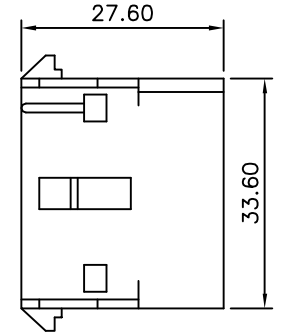

4UCON 元化興業股份有限公司
 4UCON TECHNOLOGY INC.

DRAWING No.

07045

APPROVED BY

MEI

CHECKED BY

HZF

DRAWING BY

SONG

REV. A2

UNLESS OTHERWISE SPECIFIED TOLERANCES ARE
 .X ±0.3
 .XX ±0.3
 ANG.

UNIT mm



NO.	REV.	REVISIONS	CHK	DATE
△A2		Modify Data	HZF	11/09/2012
△A1		Modify Data	HZF	06/20/2011
△A0		NEW RELEASE		