

△ SPECIFICATION
 Current:1A
 Operation Temperature: $-55^{\circ}\text{C} \sim +105^{\circ}\text{C}$
 Contact Resistance: 20 Milliohms Max.
 Insulation Resistance: 5000 Megaohms Min.
 Dielectric Strength: 1000V AC Minute
 Housing: PA6T(UL94V-0), Black
 Contact: Copper Alloys, Gold Flash Over Nickel
 No. Of Contacts: 04~100 Contacts
 RoHS Compliant

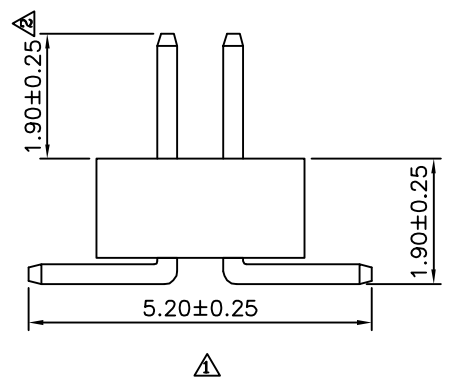
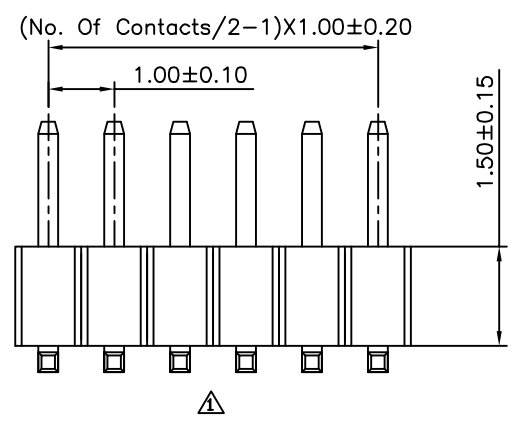

4UCON 元化興業股份有限公司
 4UCON TECHNOLOGY INC.

DRAWING No.		APPROVED BY		UNLESS OTHERWISE SPECIFIED TOLERANCES ARE .X ±0.38 .XX ±0.25 ANG. ±5°
08090		EMILY		
		CHECKED BY		
		HZF		
		DRAWING BY		
		GAO		
SCALE	NONE	REV.	A2	UNIT
				mm

NO.	REV.	REVISIONS	CHK	DATE
△A2		Modify Dim.	HZF	05/05/2012
△A1		Modify Data	HZF	03/14/2012
△A0		NEW RELEASE	HZF	06/27/2007