

Specification

1. General Information
 - . Contact Principle: Friction Technology
 - . Mounting Type: SMT
2. Material & Finish
 - . Insulator: LCP, UL94V-0, Black
 - . Data Contact: Phosphor Bronze
Gold Flash On Contact Area, Tin Plated On Solder Tails
- △ Shell: Stainless Steel
Nickel Plated, Tin Plated On Solder Area
3. Electrical Characteristics
 - . Current Rating: 1A
 - . Contact Resistance: 50 Milliohms Max. At 20mV DC
 - . Insulation Resistance: 1000 Megaohms Min. At 500V DC
 - . Withstand Voltage: 500V AC RMS At 0.5mA, For 1 Minute
4. Mechanical Characteristics
 - . Contact Force: 30g Min. Per Pin
(At Contact Travel=0.45mm)
 - . Durability: Subjected To 1000 Cycles Of Insertion
And Withdrawal (Speed: 600±3/Cycles Per Hour)
5. Environmental Characteristics
 - . Solderability: 255°C±5°C For 5±0.5 Seconds 95% Min. Of Solder Area
- △ Operating Temperature: -40°C ~ +85°C, EN60721-3-3
- △ Storage temperature: -40°C ~ +85°C, EN60721-3-3
6. RoHS Compliant

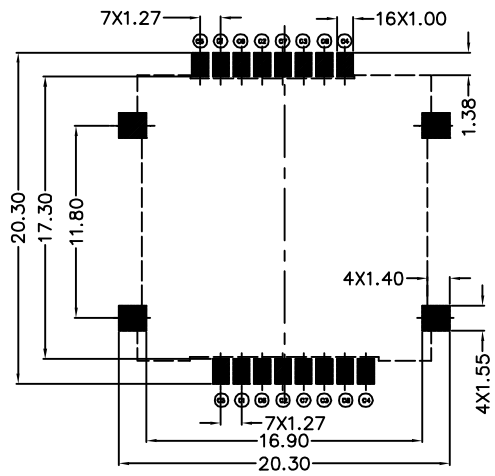
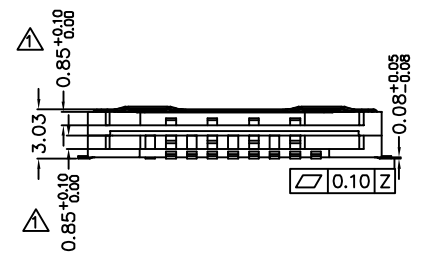

Reference P.C.B. Layout (Top View)

PCB Board Tolerance ±0.05

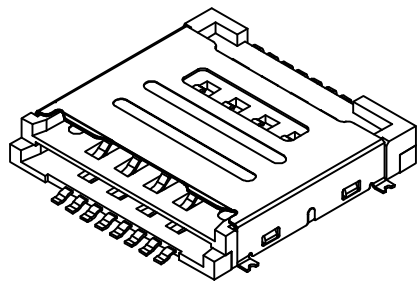

| Pin. | Assignment | Description |
|------|------------|--------------------------|
| C1 | Vcc | Power Voltage |
| C2 | RST | Reset Signal |
| C3 | CLK | Clocking Signal |
| C4 | Reserved | |
| C5 | GND | Power And Signal Ground |
| C6 | Vpp | Programming Voltage |
| C7 | I/O | Serial data Input/Output |
| C8 | Reserved | |

4UCON 元化興業股份有限公司
4UCON TECHNOLOGY INC.

| | | | | |
|-------------|--|----------------|--|--|
| DRAWING No. | | APPROVED BY | | UNLESS OTHERWISE SPECIFIED TOLERANCES ARE .X ±0.25 .XX ±0.20 ANG. UNIT mm |
| 08623 | | VIVIAN | | |
| SCALE NONE | | CHECKED BY LYS | | |
| REV. A1 | | DRAWING BY SJH | | NO. REV. |
| | | | | REVISIONS |
| | | | | CHK |
| | | | | DATE |

| | | | |
|------|-------------|-----|------------|
| △ A1 | Modify Data | SJH | 12/02/2014 |
| △ A0 | NEW RELEASE | SJH | 10/15/2014 |

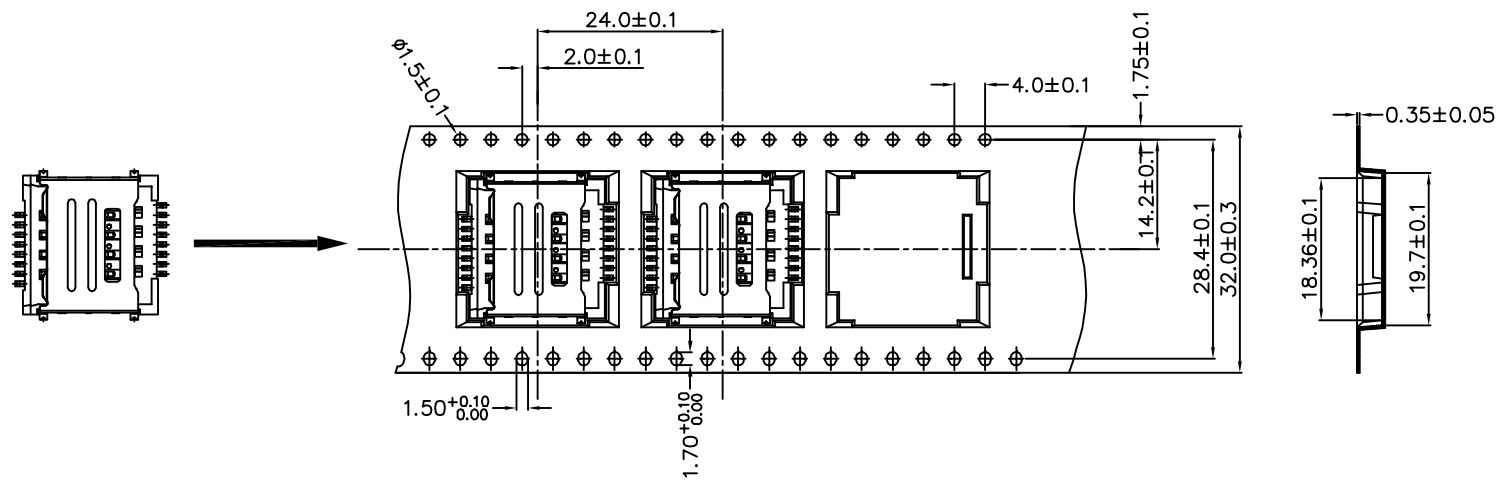

SPECIFICATIONS:
 Carrier Tape Material: Polystyrene
 Reel Material: Polystyrene
 Reel Size: 330*32.5mm
 Carton Size: 346*346*330mm
 QTY: 700Pcs/Reel
 RoHS Compliant

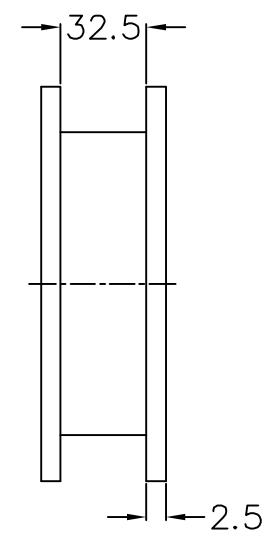
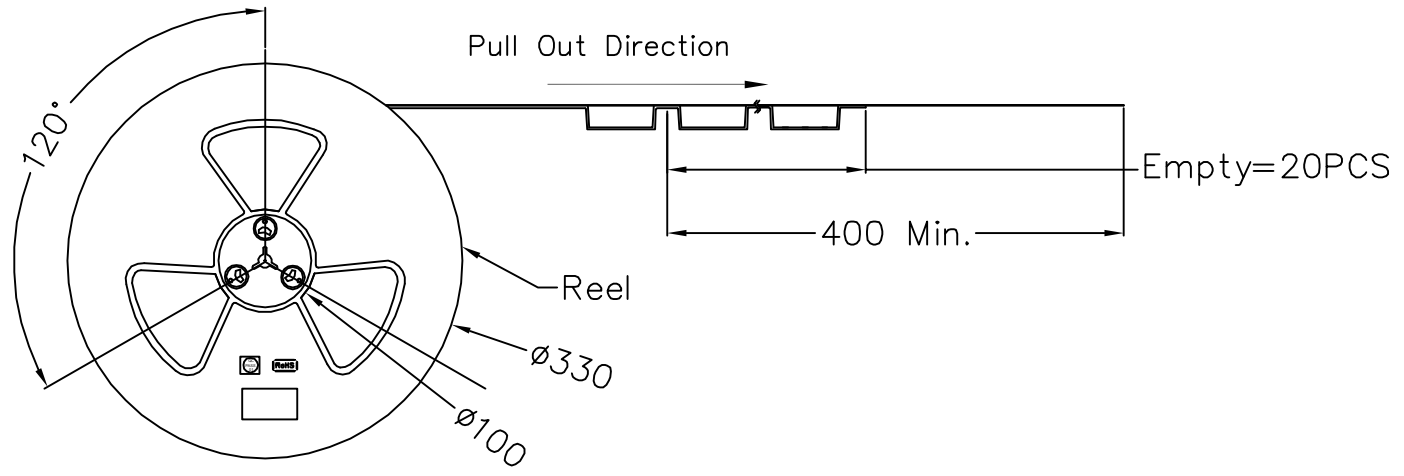
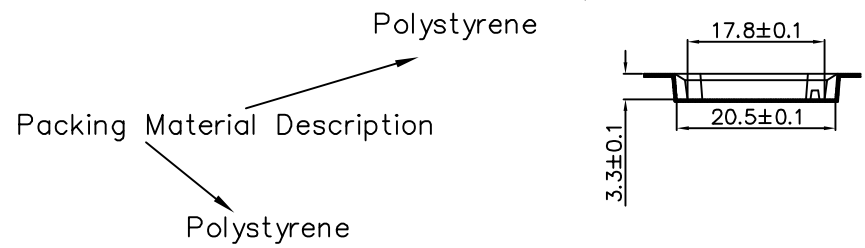

4UCON 元化興業股份有限公司
 4UCON TECHNOLOGY INC.

| | | | | | |
|-------------|------|-------------|----|----------------------------|--|
| DRAWING No. | | APPROVED BY | | UNLESS OTHERWISE SPECIFIED | |
| 08623 | | VIVIAN | | TOLERANCES ARE | |
| | | CHECKED BY | | .X | |
| | | LYS | | .XX | |
| | | DRAWING BY | | ANG. | |
| | | SJH | | UNIT | |
| SCALE | NONE | REV. | A1 | mm | |

| | | | | |
|-----|------|-------------|-----|------------|
| NO. | REV. | REVISIONS | CHK | DATE |
| △ | A1 | Modify Data | SJH | 12/02/2014 |
| △ | A0 | NEW RELEASE | SJH | 10/15/2014 |