

$B^{+0.30}_{-0.10}$ (2~10P)
 $B^{+0.40}_{-0.10}$ (11~20P)
 $B^{+0.50}_{-0.10}$ (21~28P)

$A^{+0.20}_{-0.10}$ (2~10P)
 $A^{+0.30}_{-0.10}$ (11~20P)
 $A^{+0.40}_{-0.10}$ (21~28P)

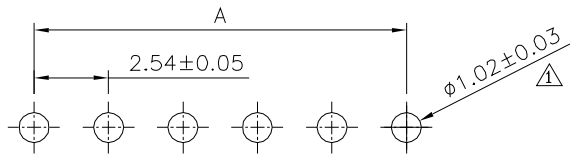
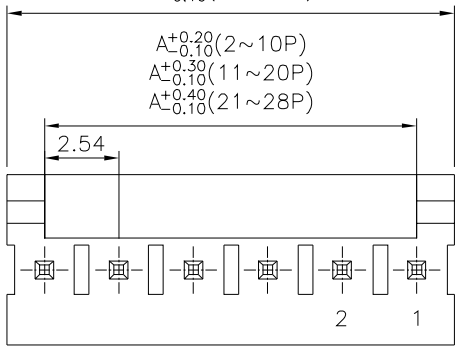

Recommended P.C.B. Layout

△△ SPECIFICATION
 Electrical Rating:UL 250V 2A,AC/DC
 CSA 250V 2A,AC/DC
 Contact:Brass,Tin Plated Over Nickel
 △ Base:PA66(UL94V-0),White
 RoHS Compliant

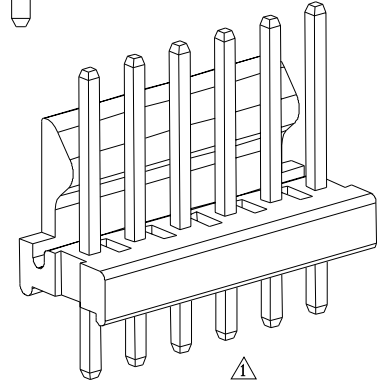
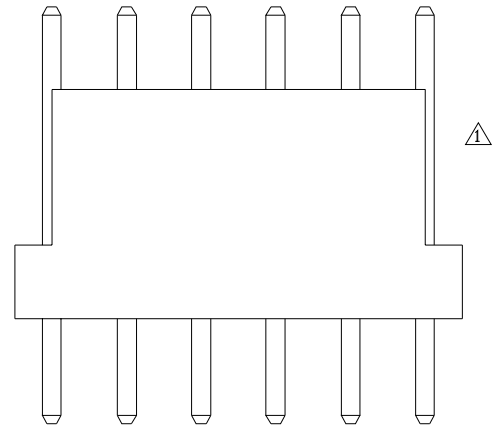
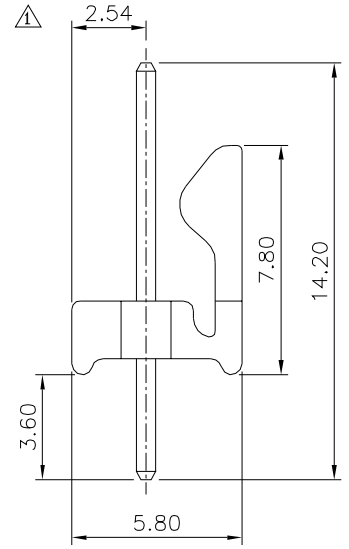
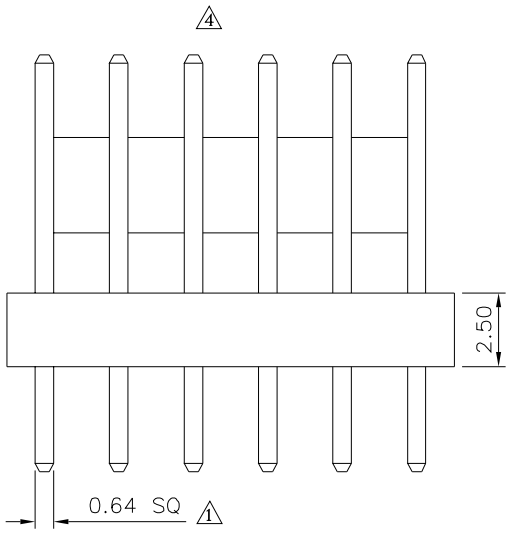

Pin	A	B
02	2.54	5.08
03	5.08	7.62
04	7.62	10.16
05	10.16	12.70
06	12.70	15.24
07	15.24	17.78
08	17.78	20.32
09	20.32	22.86
10	22.86	25.40
11	25.40	27.94
12	27.94	30.48
13	30.48	33.02
14	33.02	35.56
15	35.56	38.10
16	38.10	40.64
17	40.64	43.18
18	43.18	45.72
19	45.72	48.26
20	48.26	50.80
21	50.80	53.34
22	53.34	55.88
23	55.88	58.42
24	58.42	60.96
25	60.96	63.50
26	63.50	66.04
27	66.04	68.58
28	68.58	71.12

4UCON 元化興業股份有限公司
 4UCON TECHNOLOGY INC.

DRAWING No.		APPROVED BY		UNLESS OTHERWISE SPECIFIED TOLERANCES ARE △ .X ±0.30 △ .XX ±0.20 △ .XXX ±0.10 ANG. ±2°	△ A4	Modify Data	HZF	03/08/2024	
09440		MEI			△ A3	Modify Data	HZF	05/15/2018	
		CHECKED BY			△ A2	Modify Data	HZF	05/29/2013	
SCALE		NONE		DRAWING BY		△ A1	Modify Data	HZF	07/25/2009
		REV.		A4		△ A0	NEW RELEASE	BECKY	05/11/2005
UNIT		mm		NO.REV.		REVISIONS		CHK	DATE

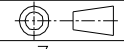

NO.	REV.	REVISIONS	CHK	DATE
-----	------	-----------	-----	------