

△△ SPECIFICATION
 Electrical Rating: UL 250V 4A, AC/DC
 CSA 125V 5A, AC/DC
 Insulator: PA66 UL94V-2, White
 Contact: Brass, Tin Plated Over Nickel
 RoHS Compliant

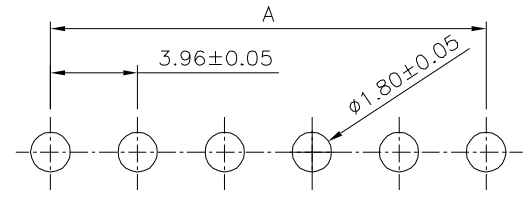

△ Recommended P.C.B. Layout

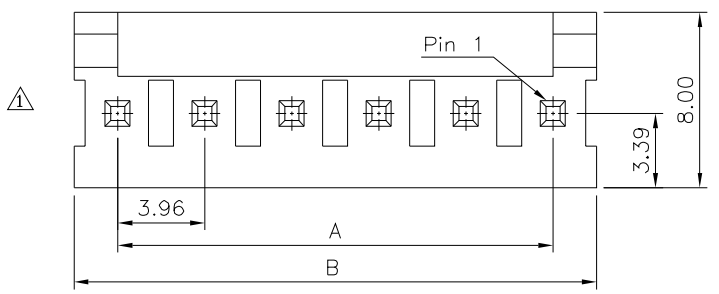
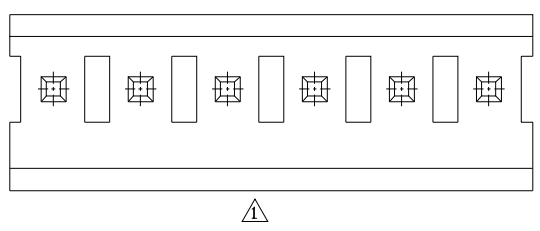
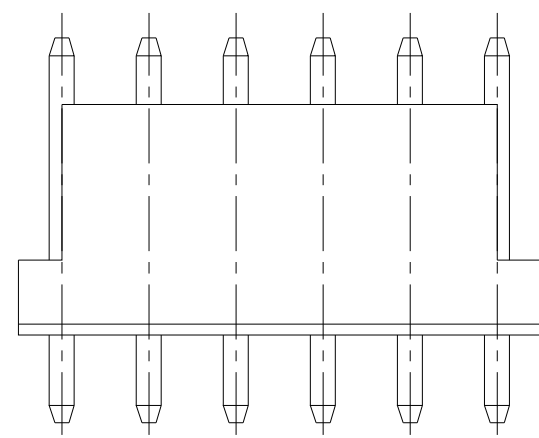
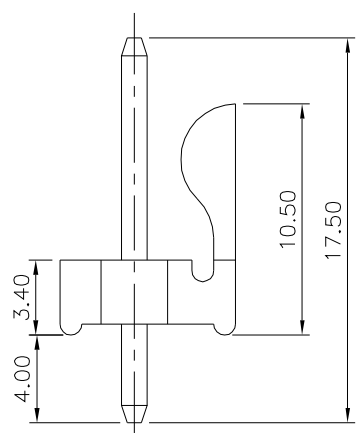
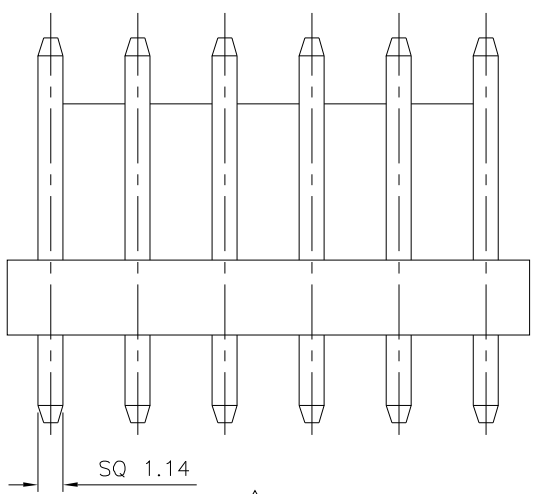

△

Circuits	A	B
2	3.96	7.92
3	7.92	11.88
4	11.88	15.84
5	15.84	19.80
6	19.80	23.76
7	23.76	27.72
8	27.72	31.68
9	31.68	35.64
10	35.64	39.60
11	39.60	43.56
12	43.56	47.52
13	47.52	51.48
14	51.48	55.44
15	55.44	59.40
16	59.40	63.36
17	63.36	67.32
18	67.32	71.28
19	71.28	75.24
20	75.24	79.20
21	79.20	83.16
22	83.16	87.12
23	87.12	91.08
24	91.08	95.04
25	95.04	99.00
26	99.00	102.96
27	102.96	106.92
28	106.92	110.88

△

Pin	UL94V-2	UL94V-0
	Tolerances(A&B)	
2-10P	+0.20/-0.10	+0.30/-0.10
11-15P	+0.30/-0.10	+0.40/-0.10
16-20P	+0.40/-0.10	+0.50/-0.10
21-28P	+0.50/-0.10	+0.60/-0.10

4UCON 元化興業股份有限公司
 4UCON TECHNOLOGY INC.

DRAWING No. △
 09516

APPROVED BY EMILY
 CHECKED BY HZF
 DRAWING BY YBL

UNLESS OTHERWISE SPECIFIED TOLERANCES ARE
 .X ±0.30
 .XX ±0.20
 .XXX ±0.10
 ANG. ±2°
 UNIT mm

NO.	REV.	REVISIONS	CHK	DATE
△3	B3	Modify Data	HZF	05/31/2022
△2	B2	Modify Data	HZF	10/18/2013
△1	B1	Modify Data	HZF	01/25/2010
△0	B0	NEW RELEASE	HZF	

SCALE NONE

REV. B3

NO. REV. REVISIONS CHK DATE