

**△ SPECIFICATION**  
 Insulator: PBT+30%G.F.(UL94V-0)  
 Contact: Brass, Tin Plated  
 RoHS Compliant

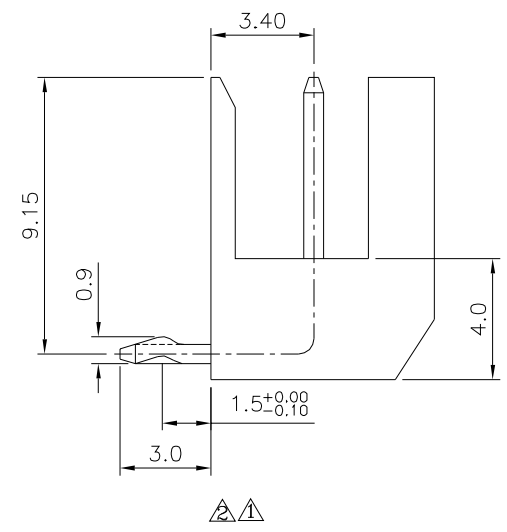
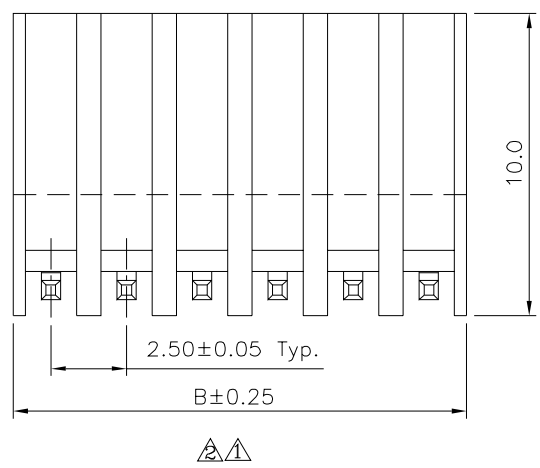

Pin	A	B	C
2	2.50	5.00	2.20
3	5.00	7.50	2.70
4	7.50	10.00	5.20
5	10.00	12.50	5.20
6	12.50	15.00	6.20
7	15.00	17.50	8.20
8	17.50	20.00	10.20
9	20.00	22.50	10.20
10	22.50	25.00	10.20
11	25.00	27.50	11.20
12	27.50	30.00	11.20
13	30.00	32.50	13.20
14	32.50	35.00	13.20

**4UCON** 元化興業股份有限公司  
 4UCON TECHNOLOGY INC.

DRAWING No.		APPROVED BY		UNLESS OTHERWISE SPECIFIED TOLERANCES ARE .X $\pm 0.25$ .XX $\pm 0.15$ .XXX $\pm 0.08$
09658		MEI		
		CHECKED BY	HZF	
		DRAWING BY	WZL	
SCALE	NONE	REV.	A2	UNIT mm

NO.	REV.	REVISIONS	CHK	DATE
△ A2		Modify Data	HZF	12/19/2023
△ A1		Modify Data	HZF	08/06/2010
△ A0		NEW RELEASE		