

SPECIFICATION
 Current Rating:3A AC/DC
 Voltage Rating:250V AC/DC
 Withstand Voltage:800V AC/Minute
 Contact Resistance:20 Milliohms Max.
 Insulation Resistance:1000 Megaohms Min.
 Temperature Range:-25°C~+85°C
 Insulator:PA66(UL94V-0),Grey
 Contact:Brass,Tin Plated
 RoHS Compliant

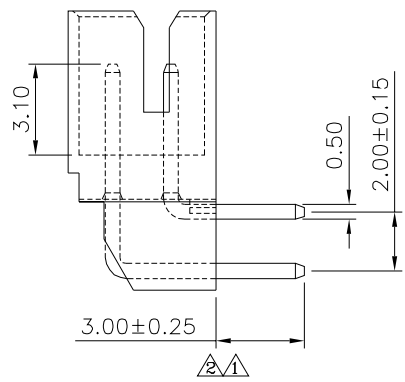
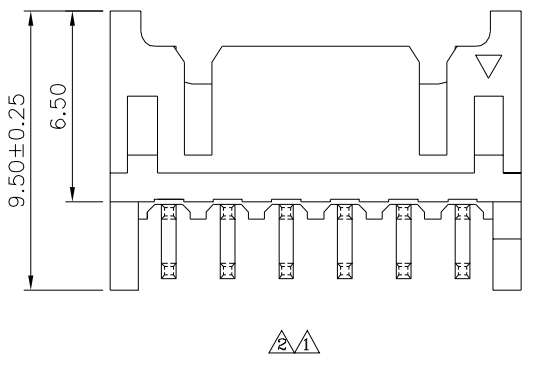
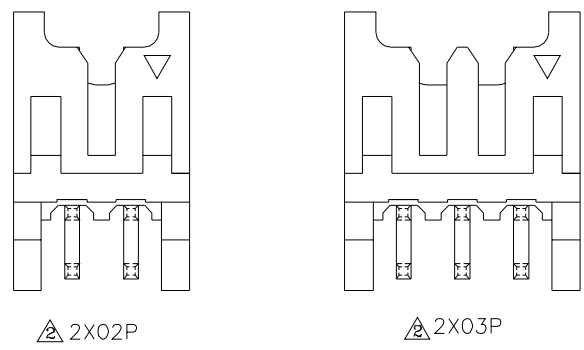
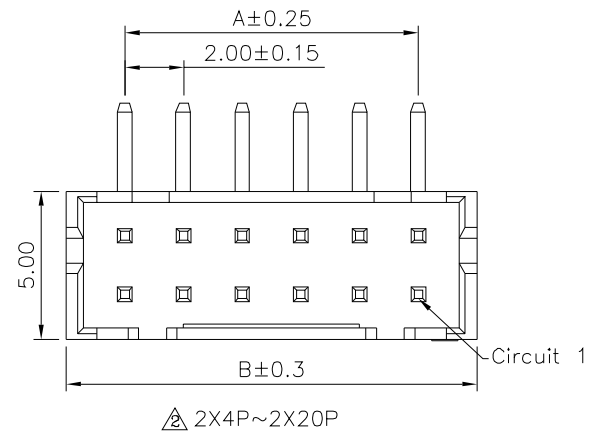

Pin	A	B
04	2.00	6.00
06	4.00	8.00
08	6.00	10.00
10	8.00	12.00
12	10.00	14.00
14	12.00	16.00
16	14.00	18.00
18	16.00	20.00
20	18.00	22.00
22	20.00	24.00
24	22.00	26.00
26	24.00	28.00
28	26.00	30.00
30	28.00	32.00
32	30.00	34.00
34	32.00	36.00
36	34.00	38.00
38	36.00	40.00
40	38.00	42.00

4UCON 元化興業股份有限公司
4UCON TECHNOLOGY INC.

DRAWING No.		APPROVED BY		UNLESS OTHERWISE SPECIFIED TOLERANCES ARE .X ±0.30 X'. ±1' .XX ±0.20 .XXX ±0.10
09723		MEI		
		CHECKED BY	HZF	
		DRAWING BY	CYP	
SCALE	NONE	REV.	A3	UNIT mm

NO.	REV.	REVISIONS	CHK	DATE
3	A3	Modify Data	HZF	11/11/2021
2	A2	Modify Data	HZF	03/02/2020
1	A1	Modify Data	HZF	01/18/2019
0	A0	NEW RELEASE	HZF	09/26/2014