

SPECIFICATIONS
 Material:P.P.
 Color:Nature Color

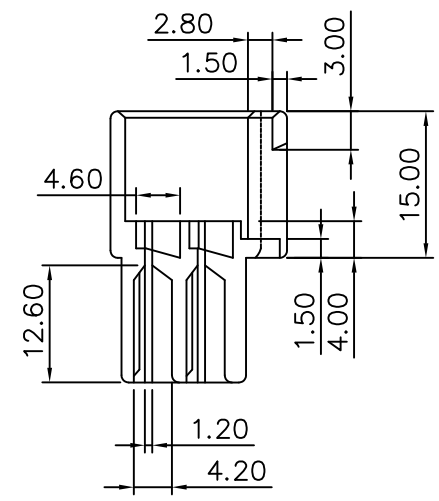

4UCON 元化興業股份有限公司
 4UCON TECHNOLOGY INC.

DRAWING No.
 11404

APPROVED BY MEI
 CHECKED BY BECKY
 DRAWING BY HZF

UNLESS OTHERWISE SPECIFIED TOLERANCES ARE
 .X ±0.38
 .XX ±0.25
 AWG.

SCALE NONE

REV. A0

UNIT mm



NO.	REV.	REVISIONS	CHK	DATE
△ A0		NEW RELEASE	BECKY	2004/07/13