

SPECIFICATION

1. **General Characteristics:**
0.5mm FPC XXP SMT 90° ZIF Bottom Contact
2. **Material&Finish:**
Insulator:PA9T(UL94V-0),Ivory
Slider:PPS(UL94V-0),Black
Terminal:Phosphor Bronze,Tin Plated Over Nickel
Me:C2680,Tin Plated Over Nickel
3. **Electrical Characteristics:**
Operation Voltage:50V Max.
Current Rating:0.5A Max.
Contact Resistance:20 Milliohms Max.
Insulation Resistance:50 Megaohms Min.
Dielectric Withstanding Voltage:250V AC RMS
4. **Environmental Characteristics:**
Operation Temperature:-40°C~+85°C
Processing Temperature:245°C±5°C For 30s
5. **Other**
Accommodated FFC/FPC Thickness:0.30±0.03mm
6. **RoHS Compliant**

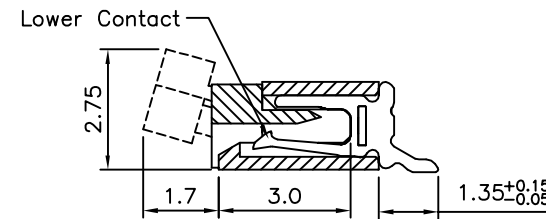
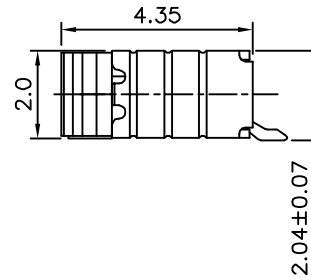
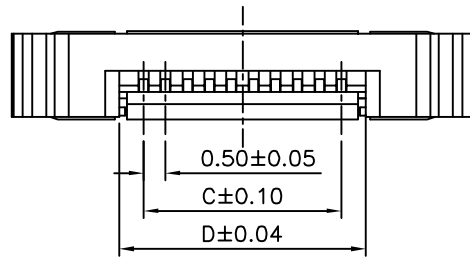
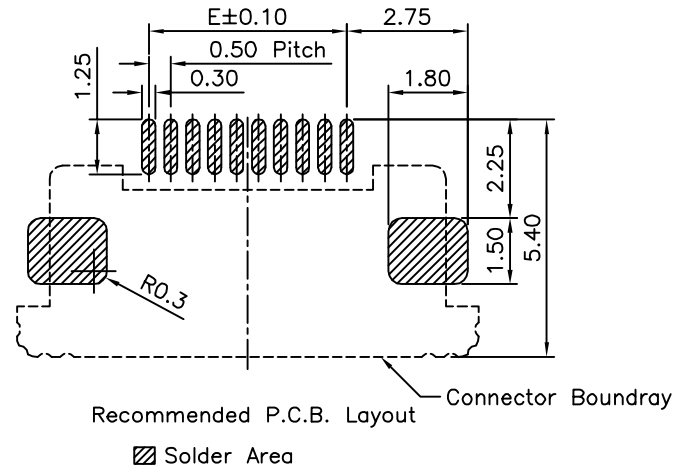
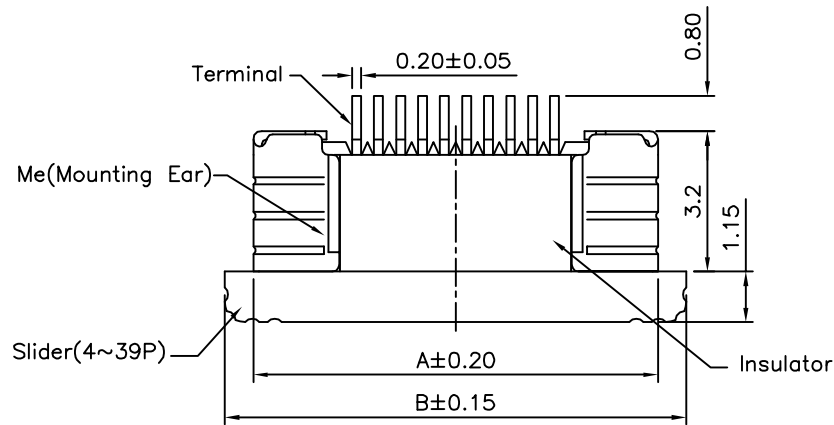

4UCON 元化興業股份有限公司
4UCON TECHNOLOGY INC.

DRAWING No.
11796

APPROVED BY
EMILY
CHECKED BY
HZF
DRAWING BY
SONG

UNLESS OTHERWISE SPECIFIED
TOLERANCES ARE
.X ±0.38
.XX ±0.20

SCALE NONE

REV. BO

UNIT mm

NO.	REV.	BO	NEW RELEASE	HZF	08/15/2013
			REVISIONS	CHK	DATE

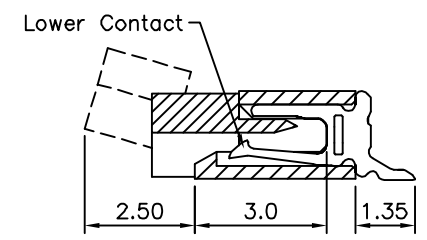
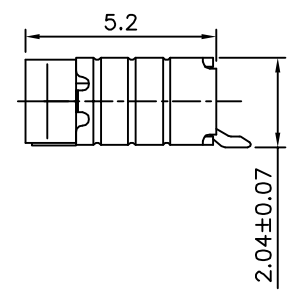
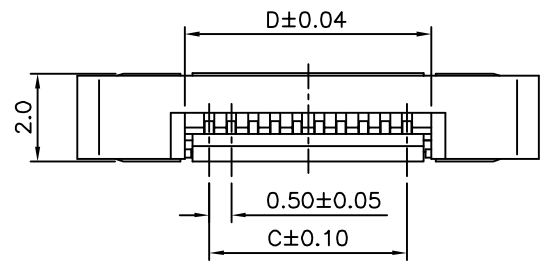
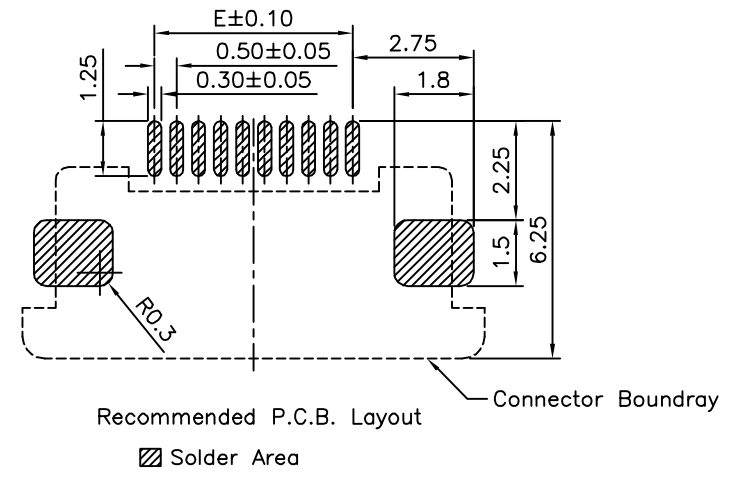
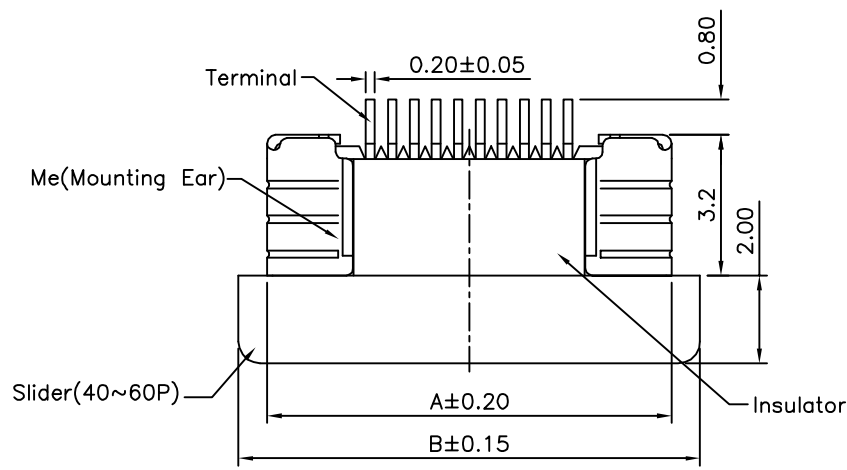

4UCON 元化興業股份有限公司
4UCON TECHNOLOGY INC.

DRAWING No.		APPROVED BY		UNLESS OTHERWISE SPECIFIED TOLERANCES ARE .X ±0.35 .XX ±0.20
11796		EMILY		
		CHECKED BY		
		HZF		
		DRAWING BY		
		SONG		
SCALE	NONE	REV.	BO	UNIT
				mm

NO.	REV.	REVISIONS	CHK	DATE
△ BO		NEW RELEASE	HZF	08/15/2013

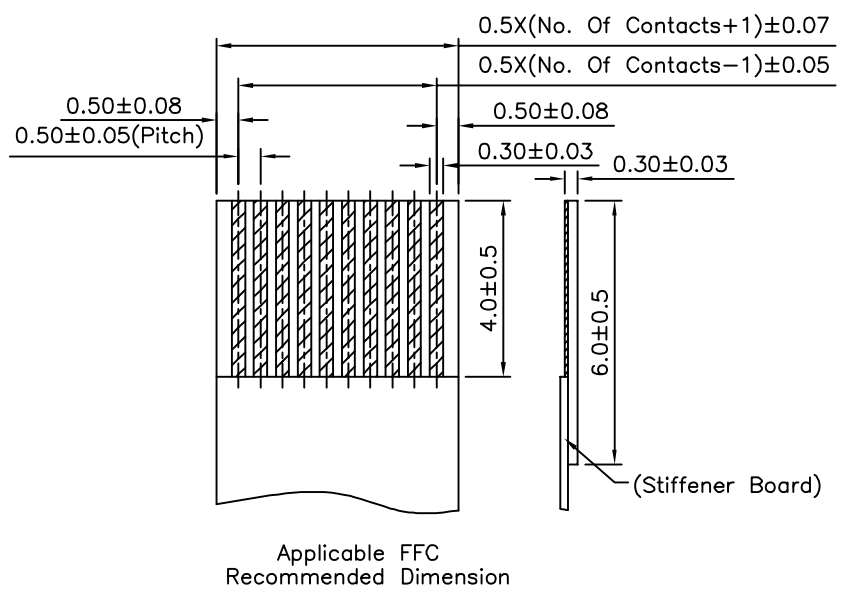
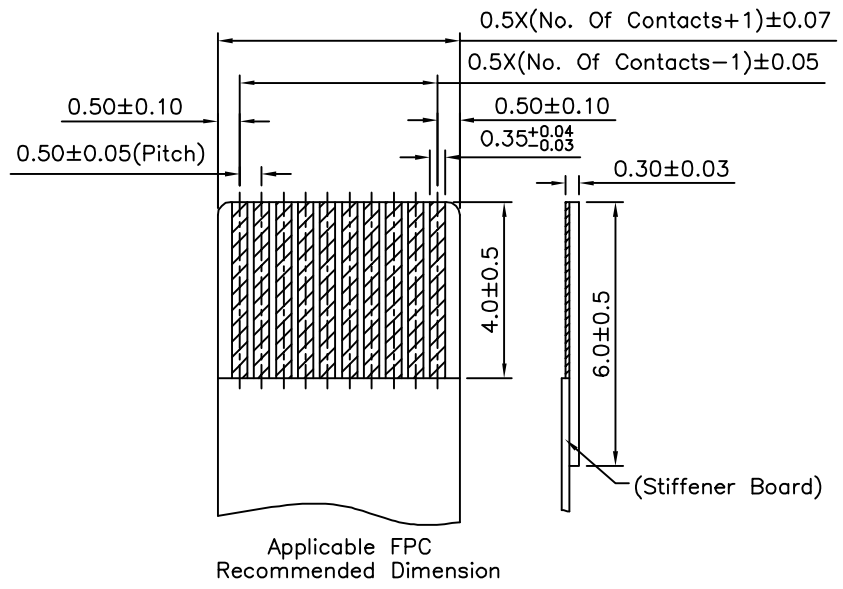

Pin	A	B	C	D	E
4	6.20	7.50	1.50	2.62	1.50
5	6.70	8.00	2.00	3.12	2.00
6	7.20	8.50	2.50	3.62	2.50
7	7.70	9.00	3.00	4.12	3.00
8	8.20	9.50	3.50	4.62	3.50
9	8.70	10.00	4.00	5.12	4.00
10	9.20	10.50	4.50	5.62	4.50
11	9.70	11.00	5.00	6.12	5.00
12	10.20	11.50	5.50	6.62	5.50
13	10.70	12.00	6.00	7.12	6.00
14	11.20	12.50	6.50	7.62	6.50
15	11.70	13.00	7.00	8.12	7.00
16	12.20	13.50	7.50	8.62	7.50
17	12.70	14.00	8.00	9.12	8.00
18	13.20	14.50	8.50	9.62	8.50
19	13.70	15.00	9.00	10.12	9.00
20	14.20	15.50	9.50	10.62	9.50
21	14.70	16.00	10.00	11.12	10.00
22	15.20	16.50	10.50	11.62	10.50
23	15.70	17.00	11.00	12.12	11.00
24	16.20	17.50	11.50	12.62	11.50
25	16.70	18.00	12.00	13.12	12.00
26	17.20	18.50	12.50	13.62	12.50
27	17.70	19.00	13.00	14.12	13.00
28	18.20	19.50	13.50	14.62	13.50
29	18.70	20.00	14.00	15.12	14.00
30	19.20	20.50	14.50	15.62	14.50
31	19.70	21.00	15.00	16.12	15.00
32	20.20	21.50	15.50	16.62	15.50
33	20.70	22.00	16.00	17.12	16.00
34	21.20	22.50	16.50	17.62	16.50
35	21.70	23.00	17.00	18.12	17.00
36	22.20	23.50	17.50	18.62	17.50
37	22.70	24.00	18.00	19.12	18.00
38	23.20	24.50	18.50	19.62	18.50
39	23.70	25.00	19.00	20.12	19.00
40	24.20	25.50	19.50	20.62	19.50
41	24.70	26.00	20.00	21.12	20.00
42	25.20	26.50	20.50	21.62	20.50
43	25.70	27.00	21.00	22.12	21.00
44	26.20	27.50	21.50	22.62	21.50
45	26.70	28.00	22.00	23.12	22.00
46	27.20	28.50	22.50	23.62	22.50
47	27.70	29.00	23.00	24.12	23.00
48	28.20	29.50	23.50	24.62	23.50
49	28.70	30.00	24.00	25.12	24.00
50	29.20	30.50	24.50	25.62	24.50
51	29.70	31.00	25.00	26.12	25.00
52	30.20	31.50	25.50	26.62	25.50
53	30.70	32.00	26.00	27.12	26.00
54	31.20	32.50	26.50	27.62	26.50
55	31.70	33.00	27.00	28.12	27.00
56	32.20	33.50	27.50	28.62	27.50
57	32.70	34.00	28.00	29.12	28.00
58	33.20	34.50	28.50	29.62	28.50
59	33.70	35.00	29.00	30.12	29.00
60	34.20	35.50	29.50	30.62	29.50

4UCON 元化興業股份有限公司
4UCON TECHNOLOGY INC.

DRAWING No.		APPROVED BY		UNLESS OTHERWISE SPECIFIED TOLERANCES ARE .X ±0.38 .XX ±0.20
11796		EMILY		
		HZF		
		DRAWING BY		
		SONG		
SCALE	NONE	REV.	BO	UNIT mm

BO	NEW RELEASE	HZF	08/15/2013
NO. REV.	REVISIONS	CHK	DATE