

Recommended P.C.B. Layout

SPECIFICATION

Current Rating:3 Amps/Contact Max.
 Contact Resistance:4 Milliohms/Contact Max.
 Insulation Resistance:5000 Megaohms Min. At 500V
 Withstanding Voltage:1000V AC/Minute
 Operating Voltage:60V AC/DC
 Operating Temperatures:-55°C~+125°C
 Pin(Outer Sleeve):Brass,Gold Flash Over All,Over Nickel
 Insulator:PPS(UL94V-0),Black
 RoHS Compliant

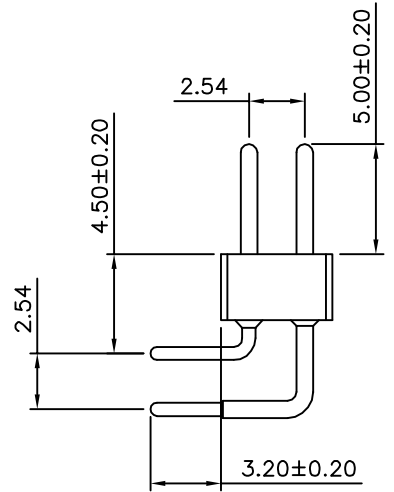
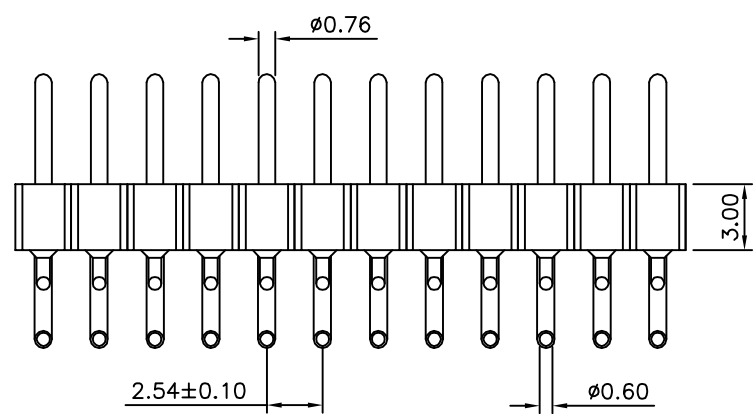
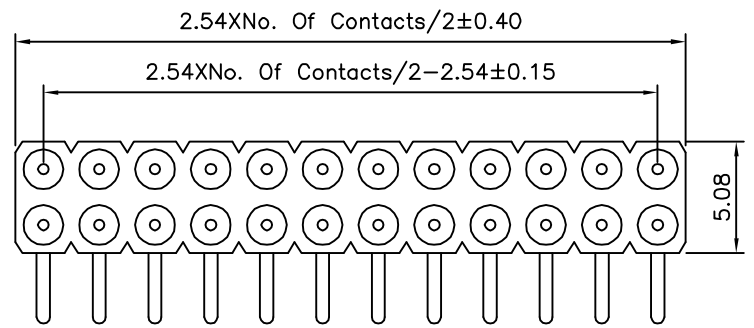

4UCON 元化興業股份有限公司
 4UCON TECHNOLOGY INC.

DRAWING No.		APPROVED BY		UNLESS OTHERWISE SPECIFIED TOLERANCES ARE X. ±0.50 XX ±0.30 XXX ±0.20 ANG. ±5°
11810		EMILY		
		CHECKED BY HZF		
		DRAWING BY HAO		
SCALE	NONE	REV.	A0	UNIT mm

NO.	REV.	REVISIONS	CHK	DATE
△ A0		NEW RELEASE	HZF	11/25/2014