

SPECIFICATION

- 1. **General Characteristics:**
0.8mm Board To Board Male XXP SMT 90° Without Post Without Fitting Nail Stacking Height=5.65/6.15mm
- 2. **Material&Finish:**
Insulator:PA46(UL94V-0),Beige
Contact:Phosphor Bronze,Gold Plated Over Nickel
- 3. **Electrical Characteristics:**
Current Rating:0.5A AC/DC
Voltage Rating:100V AC/DC
Withstanding Voltage:500V RMS For One Minute
Insulation Resistance:100 Megaohms Min.
Contact Resistance:40 Milliohms Max.
- 4. **Environmental Characteristics:**
Operation Temperature Range:-40°C~+105°C
- 5. **RoHS Compliant**

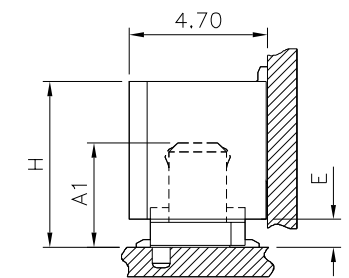
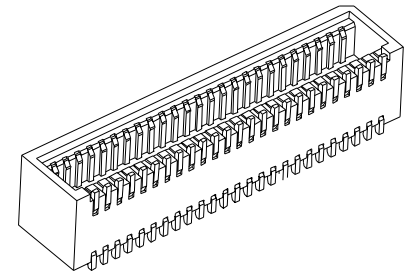

Mating Drawing(Ref)

Series No.(Plug)	Series No.(Socket)	A1	H	E
1650	1636	3.55	5.65	0.95
1650	1649	4.05	6.15	1.45

Pin	A	B	C	Pin	A	B	C
10	6.20	4.90	3.20	34	15.80	14.50	12.80
12	7.00	5.70	4.00	36	16.60	15.30	13.60
14	7.80	6.50	4.80	38	17.40	16.10	14.40
16	8.60	7.30	5.60	40	18.20	16.90	15.20
18	9.40	8.10	6.40	50	22.20	20.90	19.20
20	10.20	8.90	7.20	60	26.20	24.90	23.20
22	11.00	9.70	8.00	68	29.40	28.10	26.40
24	11.80	10.50	8.80	70	30.20	28.90	27.20
26	12.60	11.30	9.60	80	34.20	32.90	31.20
28	13.40	12.10	10.40	90	38.20	36.90	35.20
30	14.20	12.90	11.20	100	42.20	40.90	39.20
32	15.00	13.70	12.00				

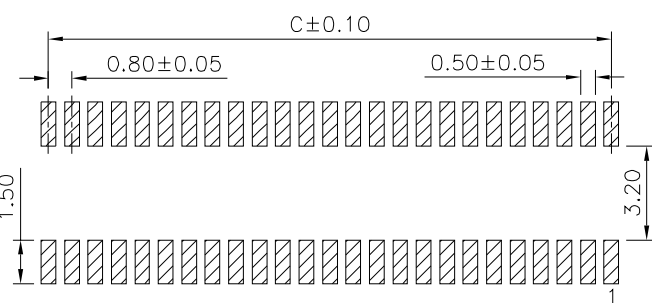

Recommended P.C.B. Layout

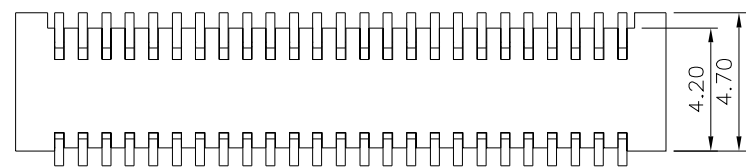
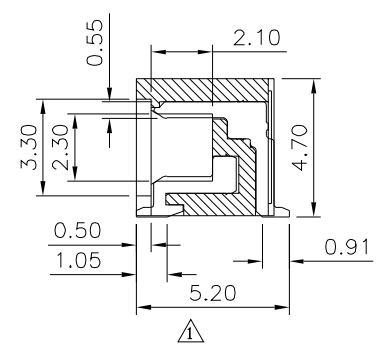
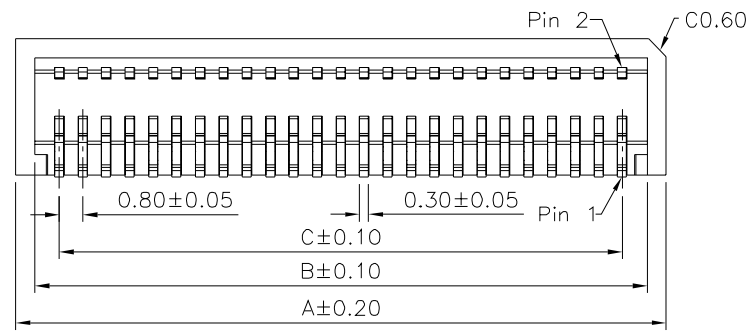
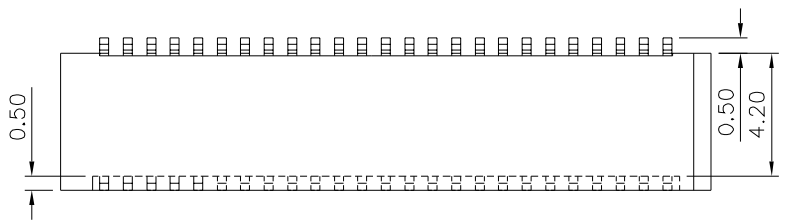

4UCON 元化興業股份有限公司
4UCON TECHNOLOGY INC.

DRAWING No.		APPROVED BY		UNLESS OTHERWISE SPECIFIED TOLERANCES ARE .X ±0.20 .XX ±0.15 ANG.
13373		MEI		
		CHECKED BY HZF		
SCALE NONE		DRAWING BY HAO		UNIT mm
REV. B1		HAO		

NO.	REV.	REVISIONS	CHK	DATE
△	B1	Modify Data	HZF	01/30/2015
△	B0	NEW RELEASE	HZF	06/13/2013