

SPECIFICATION
 Rating:100V AC 4A Max.
 Contact Resistance:Pins:30 Milliohms Max.
 Shell:50 Milliohms Max.
 Insulation Resistance:100 Megaohms Min.
 @ 500V DC
 Withstanding Voltage:250V AC RMS For 1 Minute
 RoHS Compliant

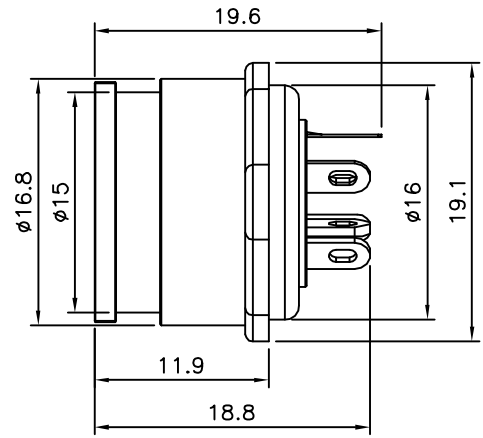
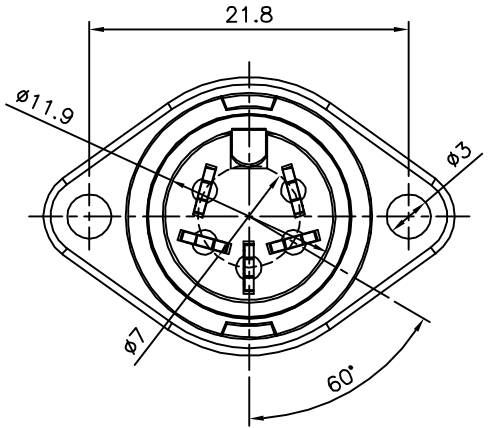
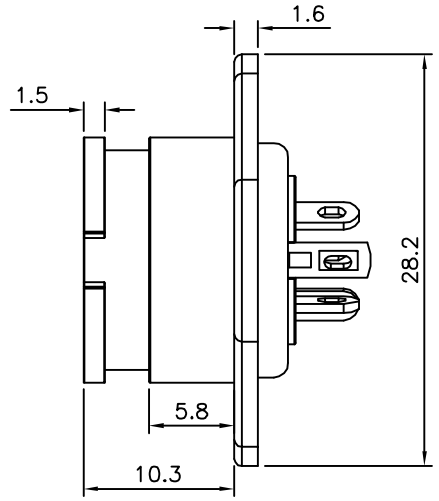

④	5P 240 Housing	PA66	UL94V-0	1
③	Terminals	Brass	Silver Plated	5
②	Negative Contactor	Copper	Nickel Plated	1
①	Shield Cover	Zn Alloy	Nickel Plated	1
No.	Description	Material	Remark	Q'ty

4UCON 元化興業股份有限公司
 4UCON TECHNOLOGY INC.

DRAWING No.		APPROVED BY		UNLESS OTHERWISE SPECIFIED TOLERANCES ARE .X ±0.25 .XX ±0.10 ANG.
13684		EMILY		
		CHECKED BY		
		HZF		
		DRAWING BY		
		SONG		
SCALE	NONE	REV.	A0	UNIT
				mm

△ A0	NEW RELEASE	HZF	02/14/2014
NO.REV.	REVISIONS	CHK	DATE