

Recommended P.C.B. Layout

△ SPECIFICATION
 △ Current:7.0A Max.
 Voltage:250V Max.
 Withstanding Voltage:1500V
 Insulation Resistance:500K Megaohms Min.
 Temperature Range:-40°C~+105°C
 △ Housing:PA66(UL94V-2),White
 △ Contact:Brass,Tin Plated Over Nickel
 RoHS Compliant

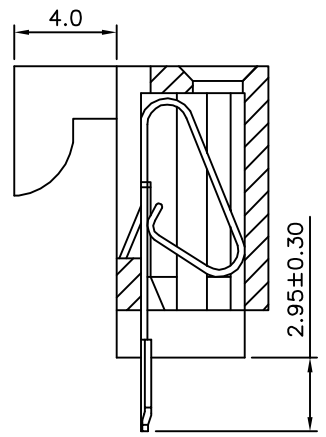
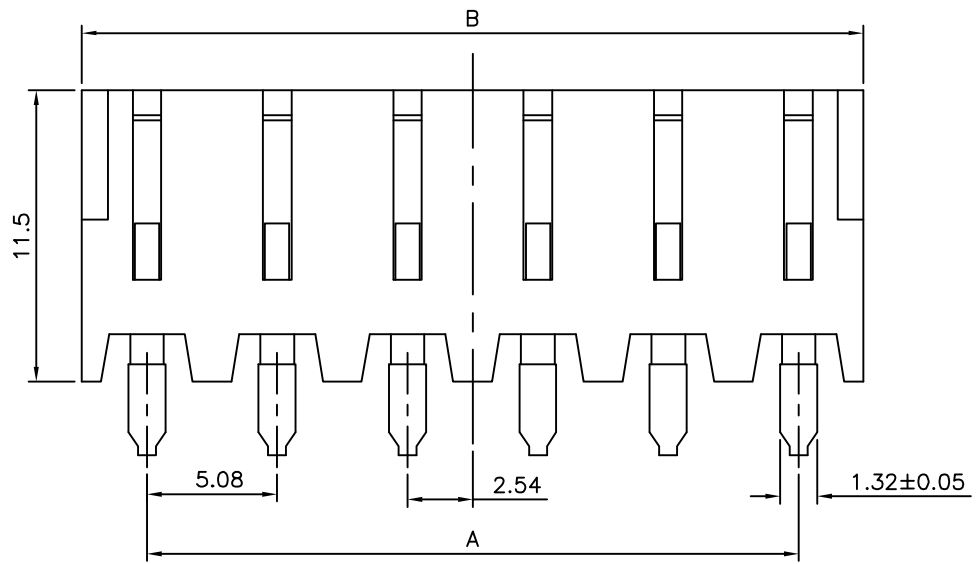
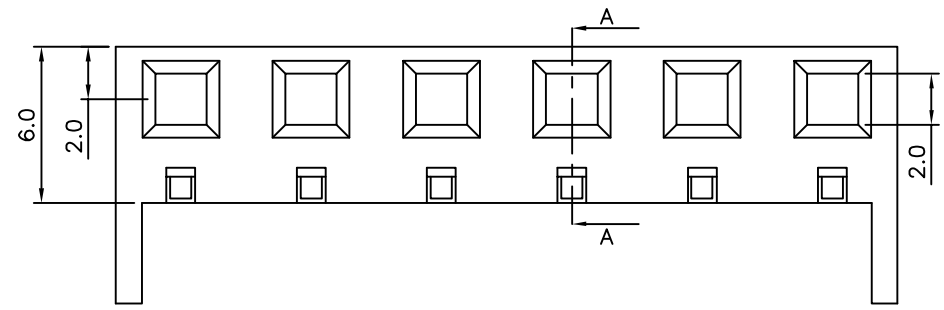

Section A-A

△ Pin	A	B
02	5.08±0.10	10.16±0.15
03	10.16±0.10	15.24±0.15
04	15.24±0.10	20.32±0.15
05	20.32±0.10	25.40±0.15
06	25.40±0.10	30.48±0.20
07	30.48±0.20	35.56±0.20
08	35.56±0.20	40.64±0.20
09	40.64±0.20	45.72±0.20
10	45.72±0.20	50.80±0.25
11	50.80±0.20	55.88±0.25
12	55.88±0.25	60.96±0.25

4UCON 元化興業股份有限公司
 4UCON TECHNOLOGY INC.

DRAWING No.		APPROVED BY		UNLESS OTHERWISE SPECIFIED TOLERANCES ARE △.X ±0.30 X.* ±1* .XX ±0.20 .X.* ±0.5* .XXX ±0.10 .XX.* ±0.25*	
14955		MEI			
		CHECKED BY	HZF		
		DRAWING BY	CYP		
SCALE	NONE	REV.	A3	UNIT	mm

NO.	REV.	REVISIONS	CHK	DATE
△ A3		Modify Data	HZF	05/20/2015
△ A2		Modify Data	HZF	07/03/2013
△ A1		Modify Data	HZF	03/27/2009
△ A0		NEW RELEASE	BECKY	2004/06/07