

**△ SPECIFICATION**

Current Rating: 2.0Amp  
 Insulator Resistance: 1000 Megaohms Min.  
 Contact Resistance: 20 Milliohms Max.  
 Withstand Voltage: 500V AC/DC  
 Operating Temperature: -40°C~+105°C  
 Contact: Phosphor Bronze, Au Plated Over Ni  
 Insulator: PA6T+30%G.F, UL 94V-0  
 RoHS Compliant

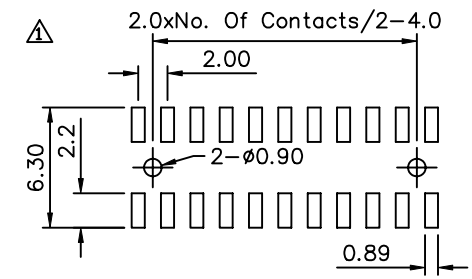

Recommended P.C.B Layout (Top Side)  
 (PCB Board Tolerance±0.05)

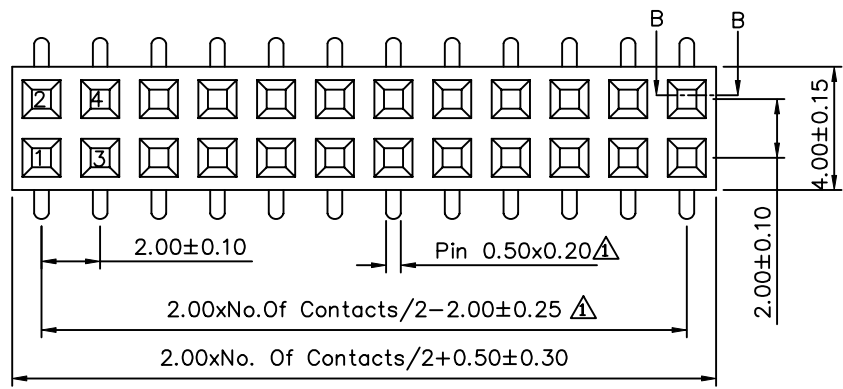
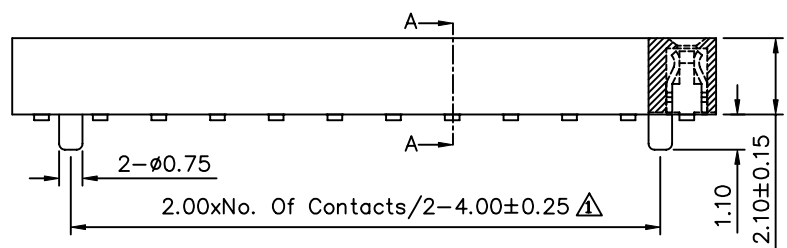

Section B-B

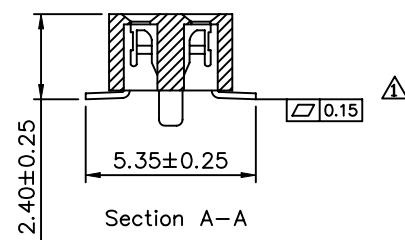

Section A-A

**4UCON** 元化興業股份有限公司  
 4UCON TECHNOLOGY INC.

DRAWING No.		APPROVED BY		UNLESS OTHERWISE SPECIFIED TOLERANCES ARE △.X ±0.40 .XX ±0.25 .XXX ±0.15 ANG. ±3°
15964		MEI		
		CHECKED BY	HZF	
		DRAWING BY	HYY	
SCALE	NONE	REV.	A1	UNIT mm

NO.	REV.	REVISIONS	CHK	DATE
△ A1		Modify Data	HZF	02/20/2009
△ A0		NEW RELEASE	BECKY	12/01/2004