

SPECIFICATION

Current Rating:3.0 Amp
 Withstand Voltage:1000V AC/DC
 Contact Resistance:20 Milliohms Max.
 Insulation Resistance:1000 Megohms Min.
 Operation Temperature:-40°C~+105°C
 Insulator:PBT(UL94V-0)
 Contact:Brass,Gold Flash Over Nickel
 Metal Latch:Zinc Alloy,Nickel Plated
 No. Of Contact:08,10,14,16,20,26,30,34,40,44,50,60,64
 Contacts Are Toolled Already
 RoHS Compliant

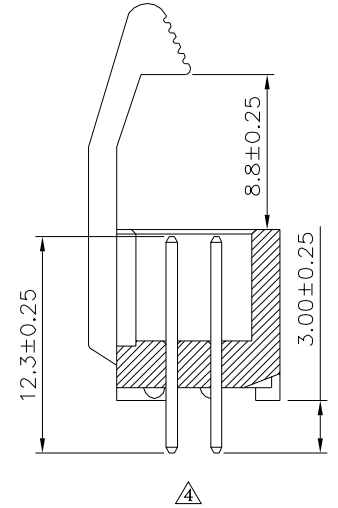
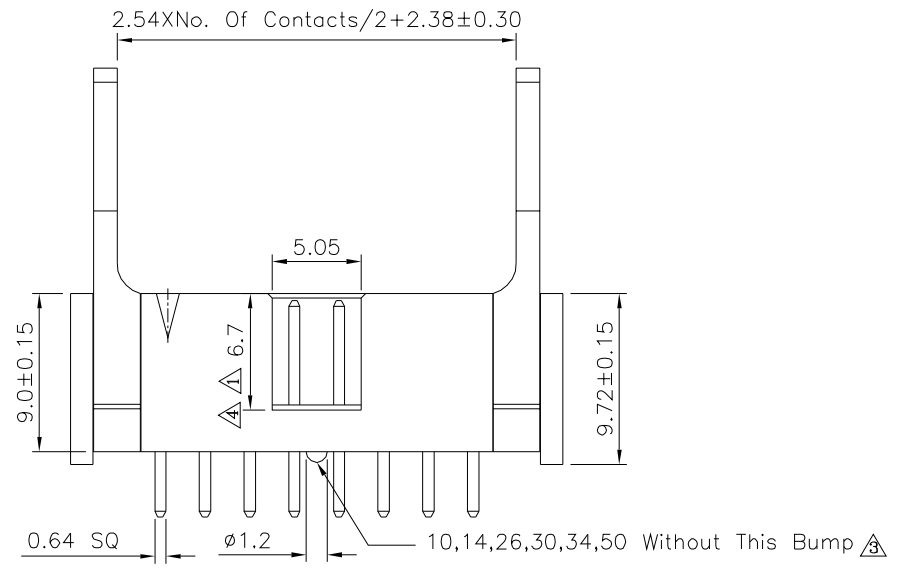
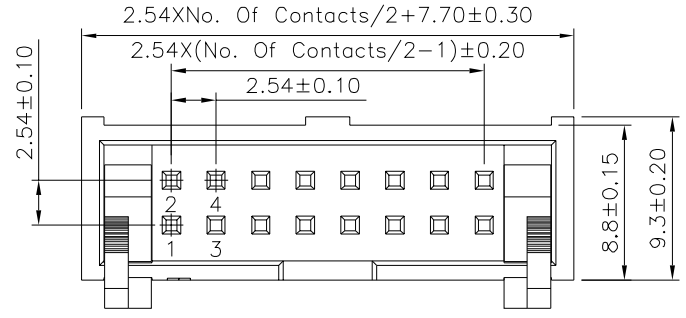

4UCON 元化興業股份有限公司
 4UCON TECHNOLOGY INC.

DRAWING No.		APPROVED BY		UNLESS OTHERWISE SPECIFIED TOLERANCES ARE X: ±0.30 X*: ±2" .X ±0.25 .X* ±1.5" .XX ±0.20 .XX* ±1" .XXX ±0.15 .XXX* ±0.5"
19037		MEI		
		HZF		
		DRAWING BY		UNIT mm
		CYP		
SCALE	NONE	REV.	A4	NO.REV.

△A4	Modify Data	HZF	01/09/2020
△A3	Modify Data	HZF	10/15/2019
△A2	Modify Data	HZF	01/09/2018
△A1	Modify Data	HZF	08/31/2016
△A0	NEW RELEASE	HZF	11/07/2014
NO.REV.	REVISIONS	CHK	DATE