

SPECIFICATION
 Current Rating:3.0Amp
 Voltage Rating:350V
 Contact Resistance:20Milliohms Max
 Insulation Resistance:1000Megohm Min
 Withstad Voltage:1000V AC/Minute
 Operation Temperature:-40°C~+105°C
 Contact Material:Brass
 Contact Plating:Au Over Ni
 Latch Material:Zinc Alloy
 Latch Plating:Ni
 Insulator Material:Polyester(UL94V-0)
 Standard:PBT+30%GF
 Above 26 Poles With "E" Profile

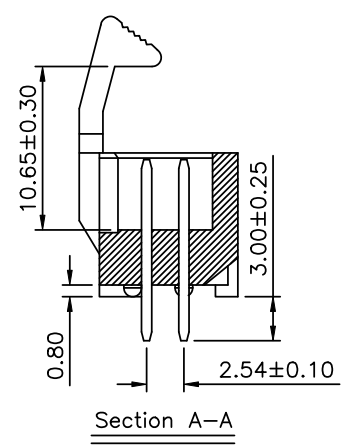
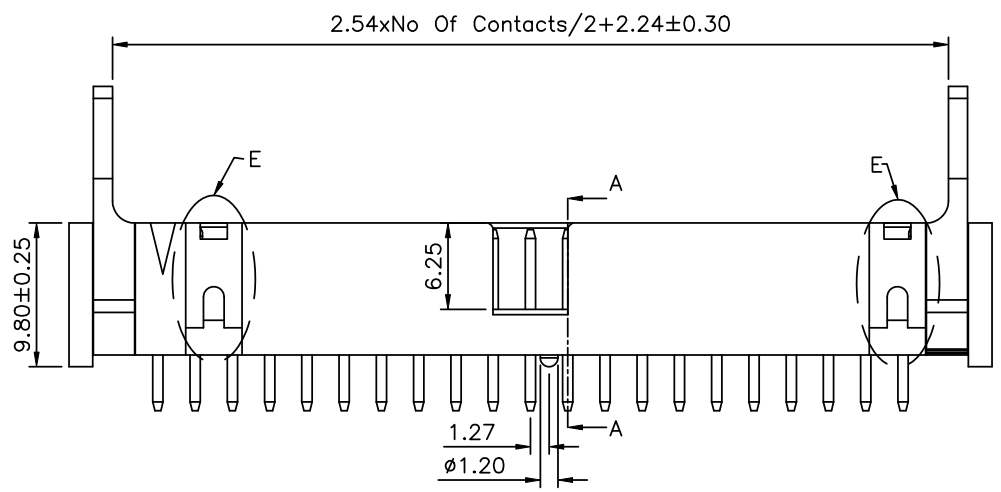
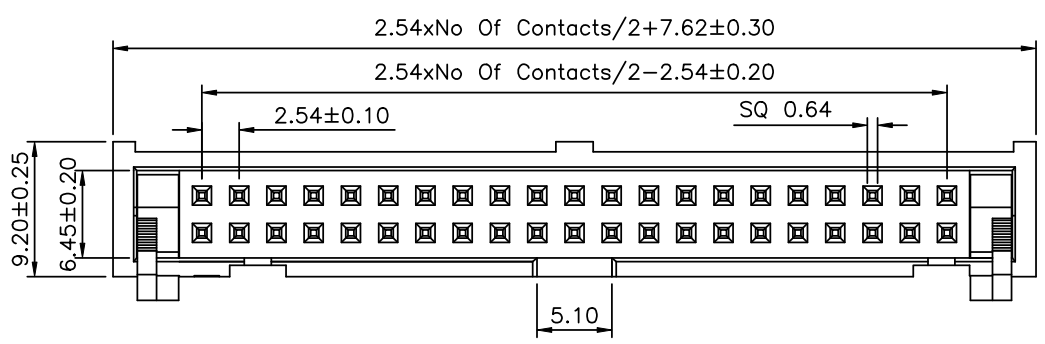

4UCON 元化興業股份有限公司
 4UCON TECHNOLOGY INC.

DRAWING No.		APPROVED BY		UNLESS OTHERWISE SPECIFIED TOLERANCES ARE .X ±0.40 .XX ±0.25 .XXX ±0.15 ANG: ±3°
19051		MEI		
		CHECKED BY	HZF	
		DRAWING BY	JLT	
SCALE	NONE	REV.	A0	UNIT mm

NO.	REV.	REVISIONS	CHK	DATE
△ A0		NEW RELEASE	HZF	11/06/2007