

SPECIFICATIONS

Insulator:Nylon,UL 94V-2
 Contact:Brass
 Applicable Wire:#26
 Electrical Rating:UL 250V 2A,AC/DC
 CSA 250V 2A,AC/DC
 Circuit: 2 ~28

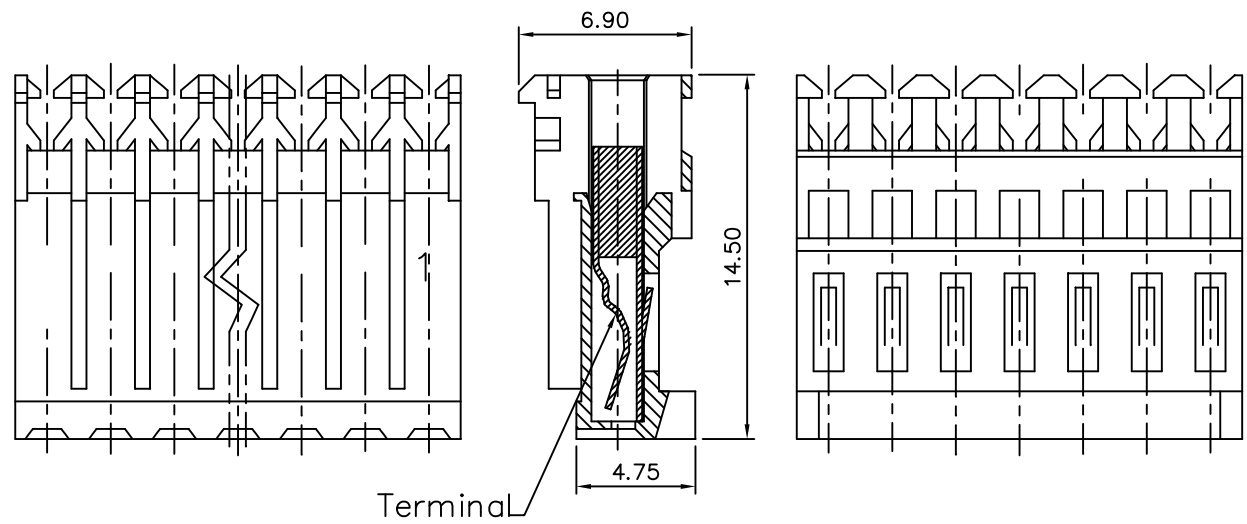
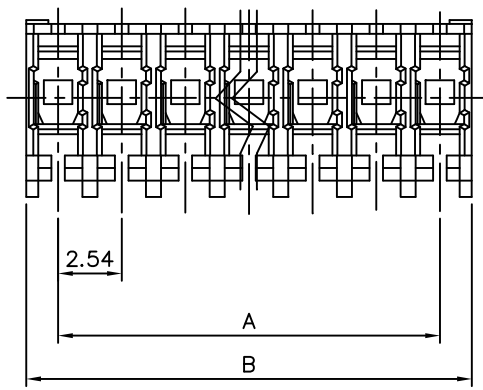

Circuits	Dim.A	Dim.B	Circuits	Dim.A	Dim.B
2	2.54	5.08	16	38.10	40.64
3	5.08	7.62	17	40.64	43.18
4	7.62	10.16	18	43.18	45.72
5	10.16	12.70	19	45.72	48.26
6	12.70	15.24	20	48.26	50.80
7	15.24	17.78	21	50.80	53.34
8	17.78	20.32	22	53.34	55.88
9	20.32	22.86	23	55.88	58.42
10	22.86	25.40	24	58.42	60.96
11	25.40	27.94	25	60.96	63.50
12	27.94	30.48	26	63.50	66.04
13	30.48	33.02	27	66.04	68.58
14	33.02	35.56	28	68.58	71.12
15	35.56	38.10			

4UCON 元化興業股份有限公司
 4UCON TECHNOLOGY INC.

DRAWING No. 19551
 APPROVED BY MEI
 CHECKED BY BECKY
 DRAWING BY TCF
 SCALE NONE REV. A0
 UNLESS OTHERWISE SPECIFIED TOLERANCES ARE
 .X ±0.30
 .XX ±0.20
 ANG.
 UNIT mm

NO.	REV.	REVISIONS	CHK	DATE
△ A0		NEW RELEASE		