

**SPECIFICATION**

Current Rating:1A AC,DC  
 Voltage Rating:50V AC,DC  
 Withstand Voltage:500V AC/Minute  
 Contact Resistance:30 Milliohms Max.  
 Insulation Resistance:100 Megaohms Min.  
 Temperature Range:-25°C~+85°C  
 Insulator:PA66(UL94V-0),Nature(Beige)  
 RoHS Compliant

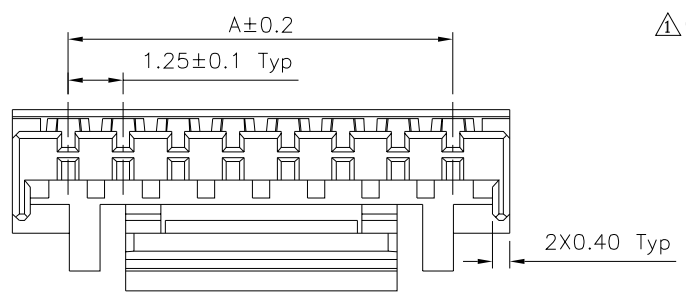
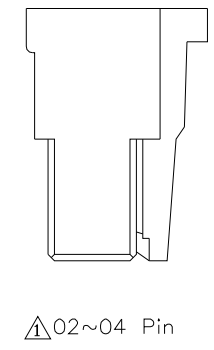
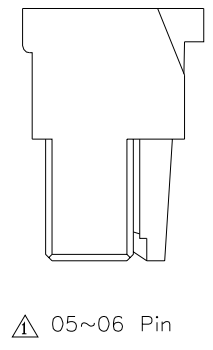
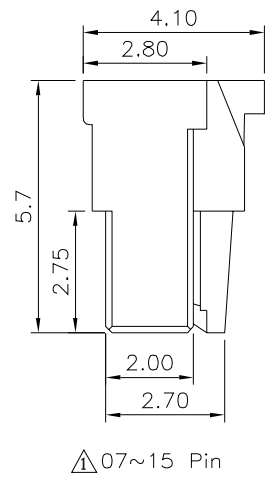
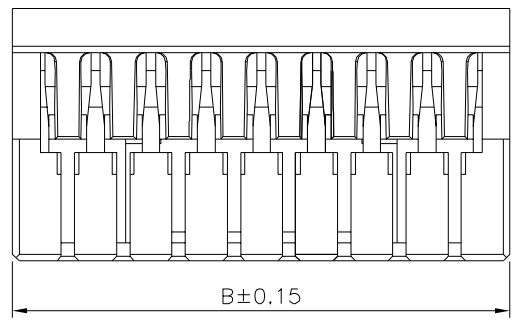
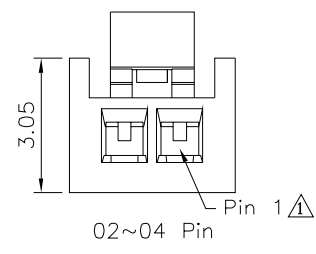
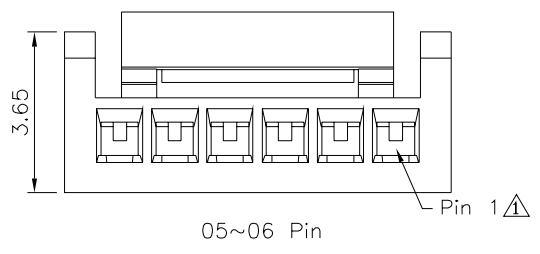
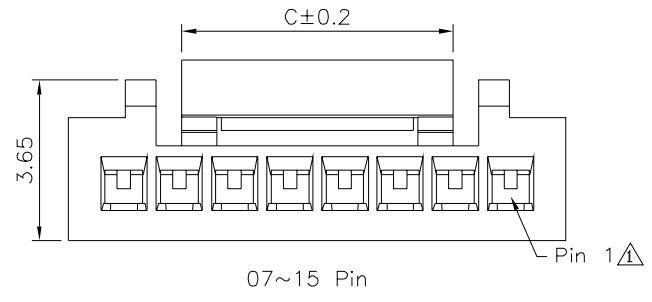

Pin	A	B	C
02	1.25	3.85	1.90
03	2.50	5.10	2.90
04	3.75	6.35	4.15
05	5.00	7.50	6.15
06	6.25	8.75	
07	7.50	10.00	8.10
08	8.75	11.25	
09	10.00	12.50	
10	11.25	13.75	
11	12.50	15.00	
12	13.75	16.25	
13	15.00	17.50	
14	16.25	18.75	
15	17.50	20.00	

**4UCON** 元化興業股份有限公司  
 4UCON TECHNOLOGY INC.

DRAWING No.		APPROVED BY		UNLESS OTHERWISE SPECIFIED TOLERANCES ARE .X ±0.25 .XX ±0.15 .XXX ±0.08 ANG. ±1°
21786		MEI		
		CHECKED BY	HZF	
		DRAWING BY	CYP	
SCALE	NONE	REV.	A1	UNIT mm

△ A1	Modify Data	HZF	09/22/2017
△ A0	NEW RELEASE	HZF	03/12/2014
NO. REV.	REVISIONS	CHK	DATE