

SPECIFICATION

Current Rating:3A AC/DC
 Voltage Rating:100V AC/DC
 Withstanding Voltage:800V AC/Minute
 Contact Resistance:25 Milliohms Max.
 Insulation Resistance:1000 Megaohms Min.
 Operation Temperature:-40°C~+125°C
 Insulator:PA66(UL94V-0),White
 RoHS Compliant

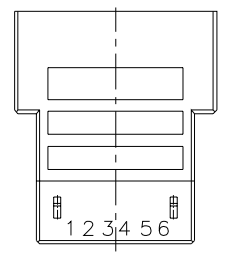

6P~15P

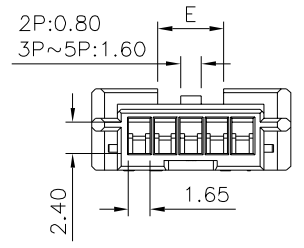
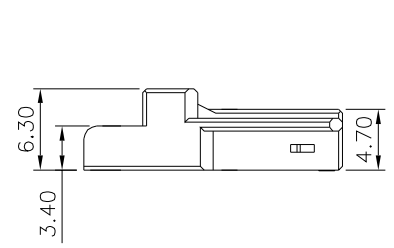
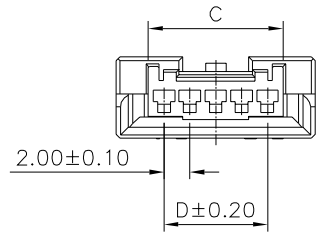
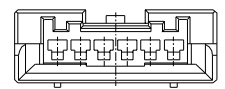
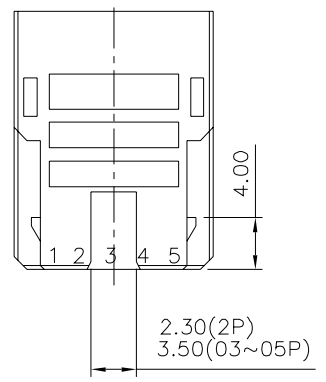

Pin	A	B	C	D	E
02	5.35	9.40	4.40		2.30
03	7.35	11.40	6.40	4.00	4.10
04	9.35	13.40	8.40	6.00	5.10
05	11.35	15.40	10.40	8.00	
06	13.65	17.40	12.40	10.00	10.00
07	15.65	19.40	14.40	12.00	
08	17.65	21.40	16.40	14.00	12.00
09	19.65	23.40	18.40	16.00	
10	21.65	25.40	20.40	18.00	17.40
11	23.65	27.40	22.40	20.00	
12	25.65	29.40	24.40	22.00	17.40
13	27.65	31.40	26.40	24.00	
14	29.65	33.40	28.40	26.00	17.40
15	31.65	35.40	30.40	28.00	

4UCON

元化興業股份有限公司
 4UCON TECHNOLOGY INC.

DRAWING No.
 22417

APPROVED BY
 MEI
 CHECKED BY
 HZF
 DRAWING BY
 LZX

UNLESS OTHERWISE SPECIFIED TOLERANCES ARE
 X. ±0.35
 .X ±0.30
 .XX ±0.20
 .XXX ±0.10

SCALE NONE REV. A0

UNIT mm

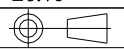

NO.	REV.	REVISIONS	CHK	DATE
△ A0		NEW RELEASE	HZF	12/06/2021

General Specification

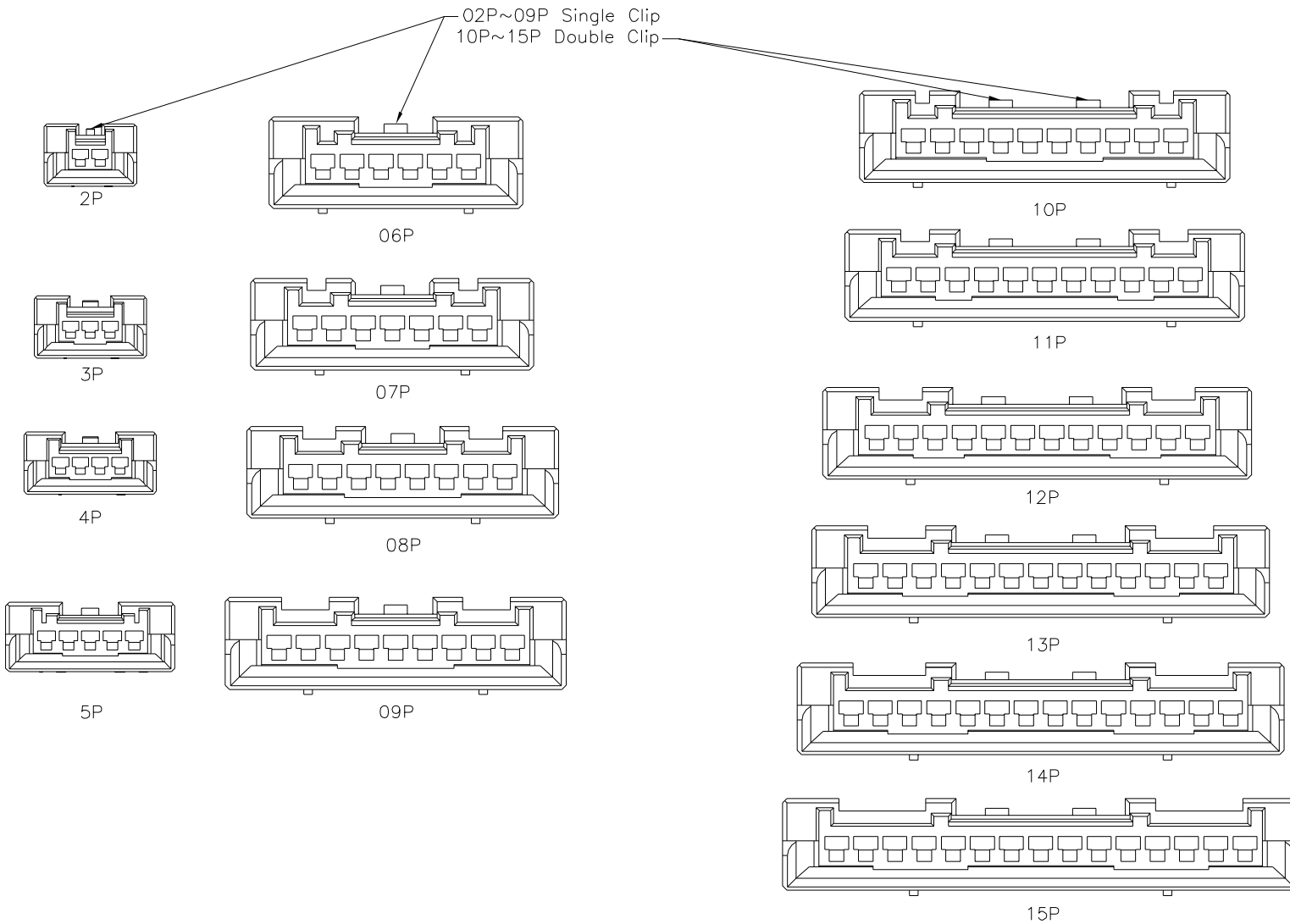

4UCON

元化興業股份有限公司
4UCON TECHNOLOGY INC.

DRAWING No.

22417

APPROVED BY

MEI

CHECKED BY

HZF

DRAWING BY

LZX

UNLESS OTHERWISE SPECIFIED TOLERANCES ARE

X. ± 0.35
.X ± 0.30
.XX ± 0.20
.XXX ± 0.10

SCALE

NONE

REV.

A0

UNIT
mm



NO. REV.

A0 NEW RELEASE

REVISIONS

HZF

CHK

12/06/2021

DATE