

**△△ SPECIFICATION**

Current Rating:5A AC,DC  
 Voltage Rating:250V AC,DC  
 Withstanding Voltage:1500V AC/Minute  
 Insulation Resistance:1000 Megaohms Min.  
 Temperature Range:-25°C~+85°C  
 Material:PA66(UL94V-2)  
 RoHS Compliant

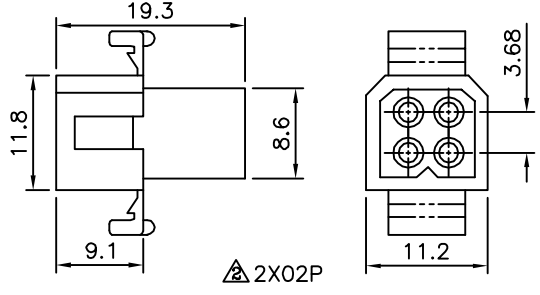
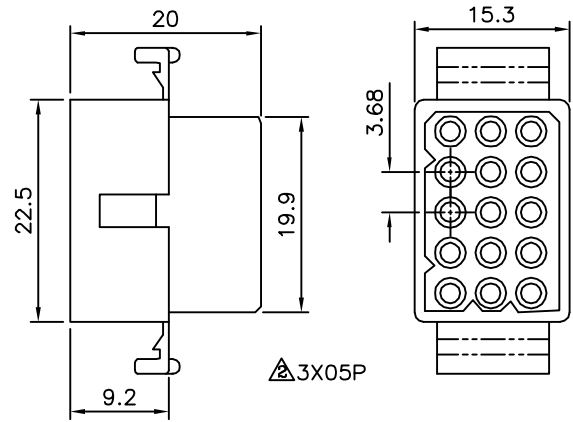
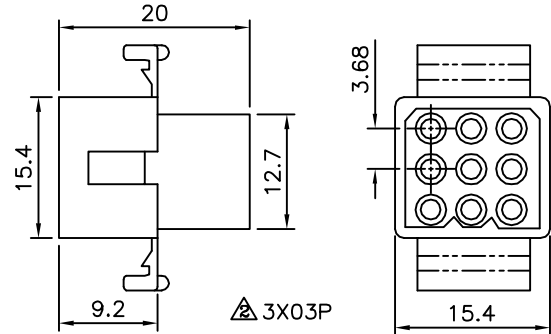
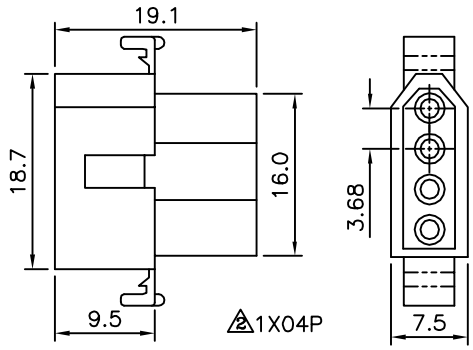
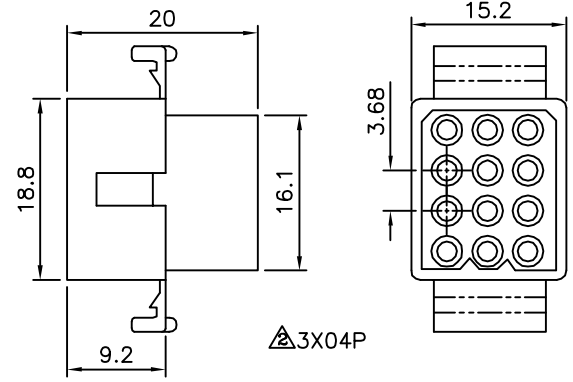
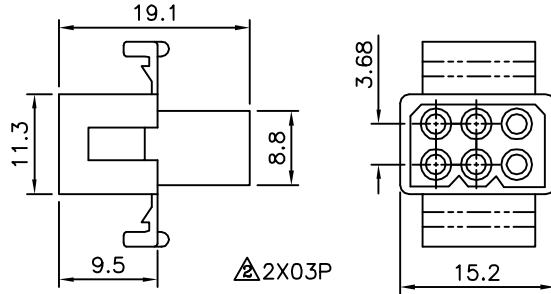
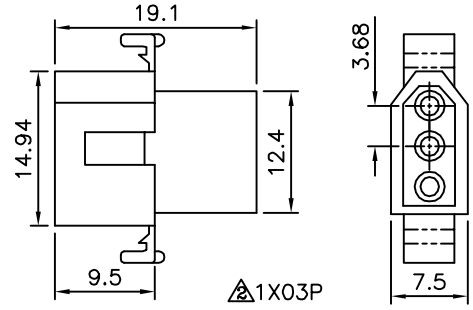
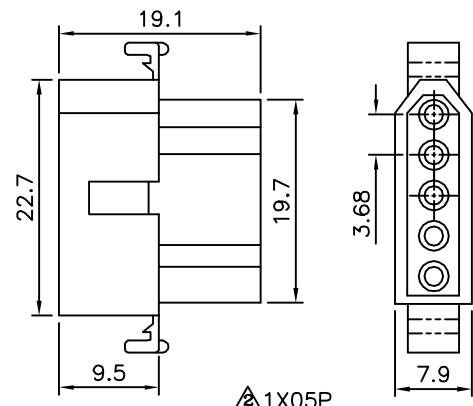
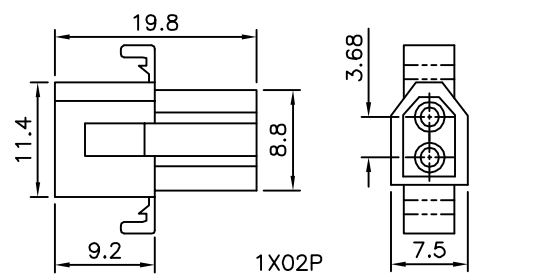

**4UCON** 元化興業股份有限公司  
 4UCON TECHNOLOGY INC.

|             |      |             |    |                                                                    |
|-------------|------|-------------|----|--------------------------------------------------------------------|
| DRAWING No. |      | APPROVED BY |    | UNLESS OTHERWISE SPECIFIED TOLERANCES ARE<br>X. ±0.3<br>.X ±0.3 △△ |
| 02098       |      | EMILY       |    |                                                                    |
|             |      | CHECKED BY  |    |                                                                    |
|             |      | HZF         |    |                                                                    |
|             |      | DRAWING BY  |    |                                                                    |
|             |      | SONG        |    |                                                                    |
| SCALE       | NONE | REV.        | A2 | UNIT mm                                                            |

|     |      |             |     |            |
|-----|------|-------------|-----|------------|
| NO. | REV. | REVISIONS   | CHK | DATE       |
| △A2 |      | Modify Data | HZF | 07/01/2014 |
| △A1 |      | Modify Data | HZF | 08/01/2009 |
| △A0 |      | NEW RELEASE |     |            |