

Material : Nylon66

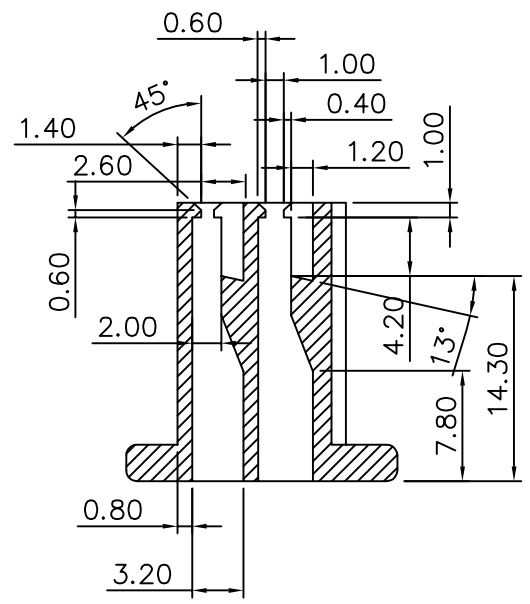
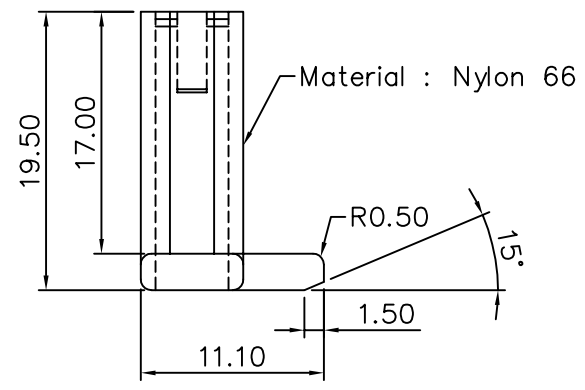
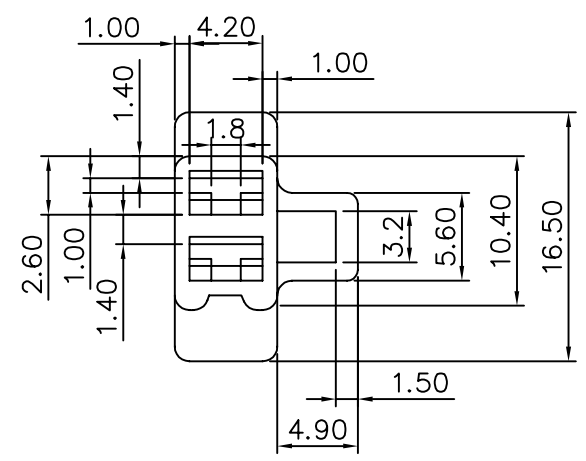

4UCON 元化興業股份有限公司
4UCON TECHNOLOGY INC.

DRAWING No.
02510

APPROVED BY MEI
CHECKED BY RAN
DRAWING BY HZF

UNLESS OTHERWISE SPECIFIED
TOLERANCES ARE
.X ±0.38
.XX ±0.25
ANG.

SCALE NONE

REV. A

UNIT mm

AREA REVISIONS CHK DATE