

Recommended P.C.B. Layout

**SPECIFICATION**  
 Current Rating:1.5 Amp  
 Withstand Voltage:500V AC  
 Contact Resistance:20 Milliohms Max.  
 Insulation Resistance:1000 Megaohms Min.  
 Operation Temperature:-40°C~+105°C  
 Insulator:PA6T(UL94V-0),Black  
 Contact:Brass,Gold Plated Over Nickel  
 RoHS Compliant

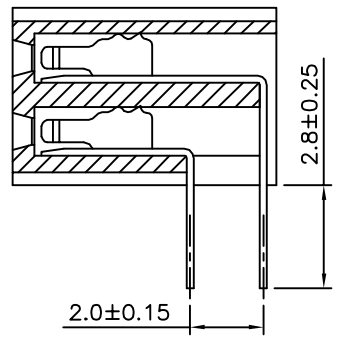
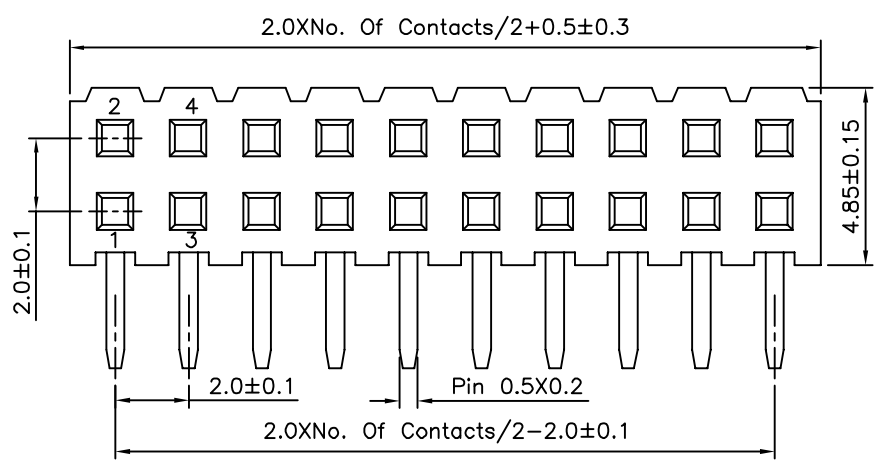
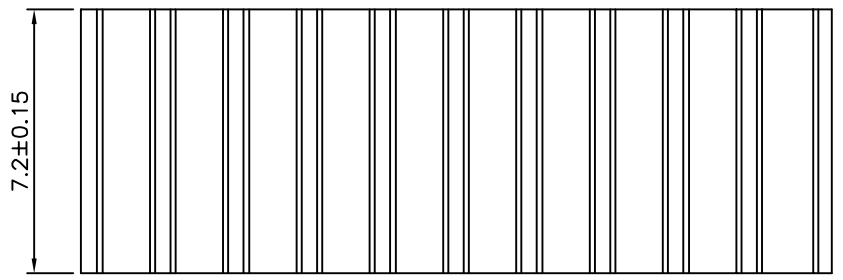

**4UCON** 元化興業股份有限公司  
 4UCON TECHNOLOGY INC.

DRAWING No.		APPROVED BY		UNLESS OTHERWISE SPECIFIED TOLERANCES ARE >80 ±1.20 25~80 ±0.15 5~25 ±0.10 <5 ±0.05 ANG. ±0.03°
00406		EMILY		
		CHECKED BY HZF		
		DRAWING BY GAO		
SCALE	NONE	REV.	A0	UNIT mm

NO.	REV.	REVISIONS	CHK	DATE
△ A0		NEW RELEASE	HZF	12/25/2012