

Recommended P.C.Board Layout

△△ SPECIFICATION
 Current Rating:1A AC/DC
 Voltage Rating:125V AC/DC
 Withstand Voltage:250V AC For 1 Minute
 Contact Resistance:20 Milliohms Max.
 Insulation Resistance:100 Megohms Min.
 Operation Temperature:-40°C~+85°C
 Insulator:HTN(UL94V-0),Nature
 Contact:Phosphor Bronze,Tin Plated Over Nickel
 Tab:Brass,Tin Plated Over Nickel
 RoHS Compliant

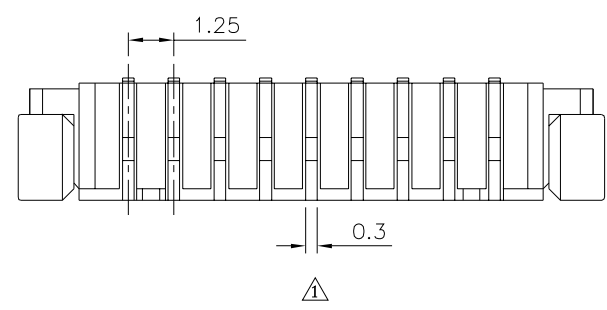
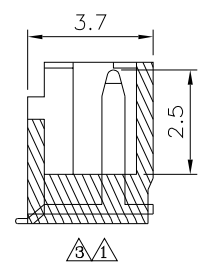
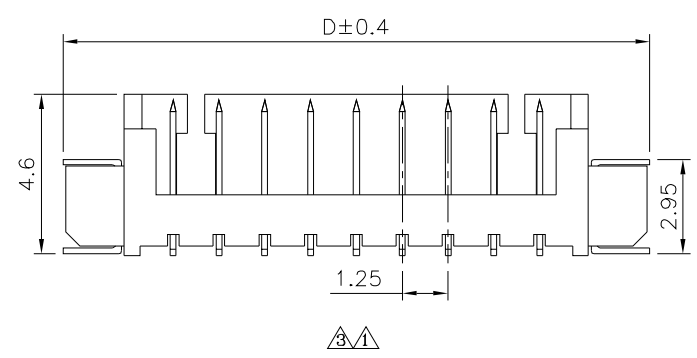

Pin	A	B	C	D
2	1.25	3.05	4.25	7.65
3	2.50	4.30	5.50	8.90
4	3.75	5.55	6.75	10.15
5	5.00	6.80	8.00	11.40
6	6.25	8.05	9.25	12.65
7	7.50	9.30	10.50	13.90
8	8.75	10.56	11.75	15.15
9	10.00	11.80	13.00	16.40
10	11.25	13.05	14.25	17.65
11	12.50	14.30	15.50	18.90
12	13.75	15.55	16.75	20.15
13	15.00	16.80	18.00	21.40
14	16.25	18.05	19.25	22.65
15	17.50	19.30	20.50	23.90

4UCON 元化興業股份有限公司
 4UCON TECHNOLOGY INC.

DRAWING No. **△**
01241

APPROVED BY EMILY
 CHECKED BY HZF
 DRAWING BY CYP

SCALE NONE REV. A3

UNLESS OTHERWISE SPECIFIED TOLERANCES ARE
 .X ±0.25
 .XX ±0.15
 ANG.

UNIT mm

NO.	REV.	REVISIONS	CHK	DATE
△3	A3	Modify Data	HZF	12/31/2014
△2	A2	Modify Data	HZF	04/09/2012
△1	A1	Modify Data	HZF	11/10/2011
△0	A0	NEW RELEASE	SHIN	01/10/2007