

**△△ SPECIFICATION**  
 Current Rating:2A  
 Voltage Rating:100V AC  
 Contact Resistance:20 Milliohms Max.  
 Dielectric Withstanding Voltage:800V AC/Minute  
 Insulation Resistance:1000 Megaohms Min.  
 Temperature Range:-25°C~+85°C  
 Insulator:PA66(UL94V-0),White  
 Contact:Brass,Tin Plated  
 RoHS Compliant

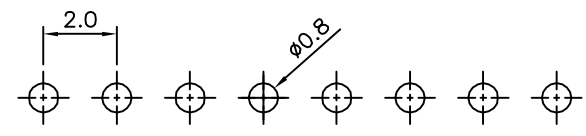

Recommended P.C.B. Layout

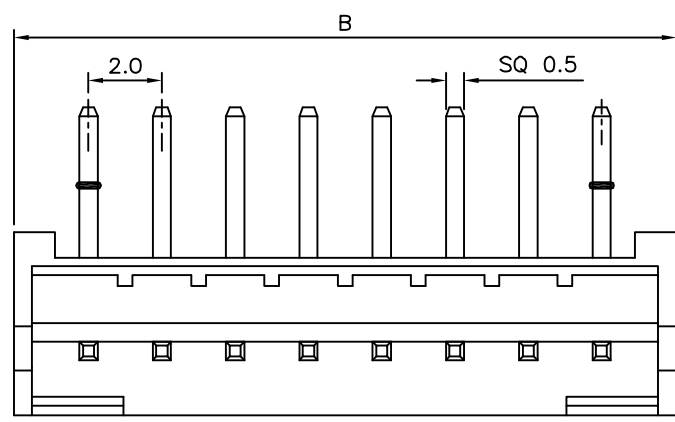

△△

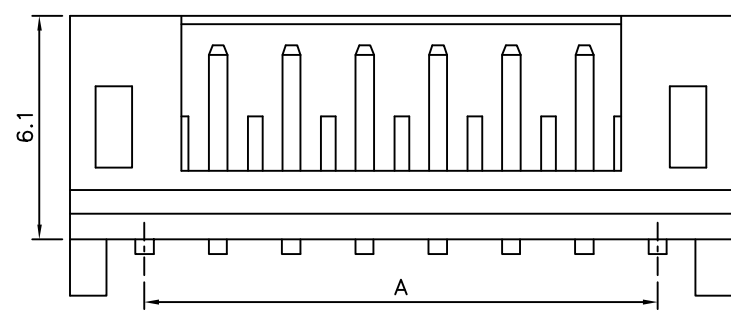

△△

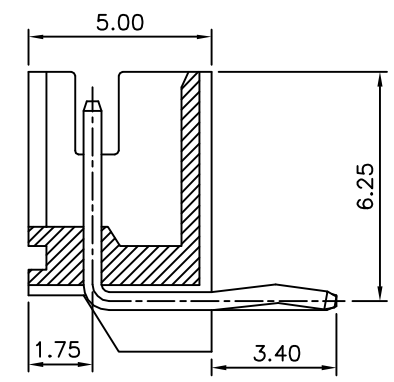

△△

Pin	A	B
2	2.0	6.04
3	4.0	8.04
4	6.0	10.04
5	8.0	12.04
6	10.0	14.06
7	12.0	16.06
8	14.0	18.08
9	16.0	20.08
10	18.0	22.10
11	20.0	24.10
12	22.0	26.12
13	24.0	28.12
14	26.0	30.14
15	28.0	32.14
16	30.0	34.14

**4UCON** 元化興業股份有限公司  
 4UCON TECHNOLOGY INC.

DRAWING No.		APPROVED BY		UNLESS OTHERWISE SPECIFIED TOLERANCES ARE .X ±0.3 .XX ±0.2
01559		MEI		
		CHECKED BY	HZF	
SCALE	NONE	DRAWING BY	HAO	
		REV.	A3	UNIT mm

NO.	REV.	REVISIONS	CHK	DATE
△	A3	Modify Data	HZF	01/06/2016
△	A2	Modify Data	HZF	03/23/2010
△	A1	Modify Data	BECKY	2005/02/17
△	A	NEW RELEASE		