

△ SPECIFICATION
 Current Rating:1 Amp
 Voltage Rating:250V AC RMS
 Dielectric Withstanding Voltage:500V AC RMS 60Hz
 For 1 Minute
 Contact Resistance:30 Milliohms Max. At 1 Amp DC
 Insulation Resistance:1000 Megohms Min.
 At 500V DC
 Temperature Range:-55°C~+85°C
 Insulator:PA66+G.F.
 Contact:Brass
 Gold Flash On Contact Area,Tin Plated
 On Solder Tails,Over Nickel
 RoHS Compliant

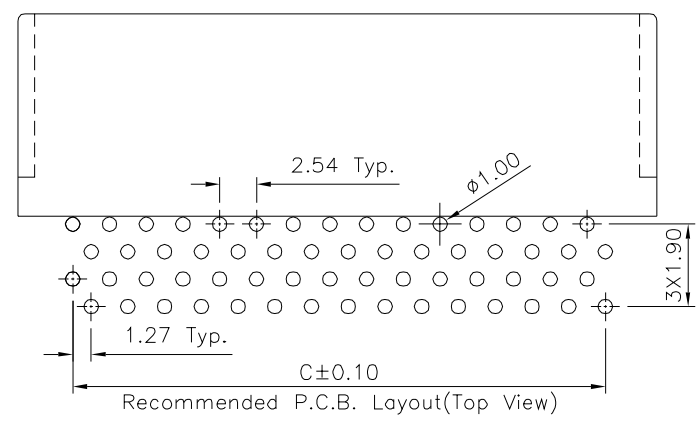
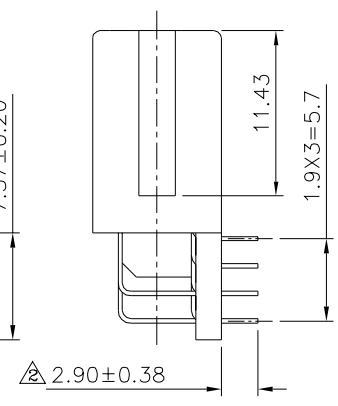
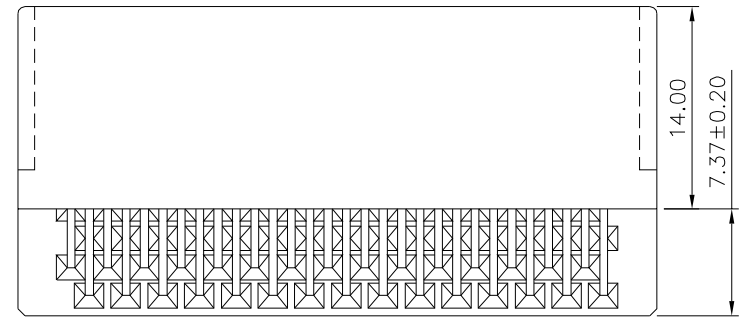
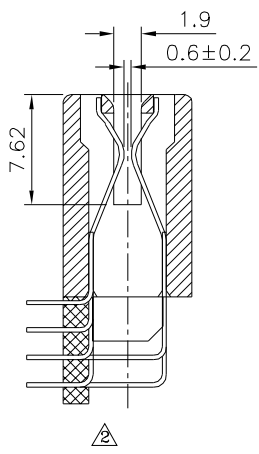
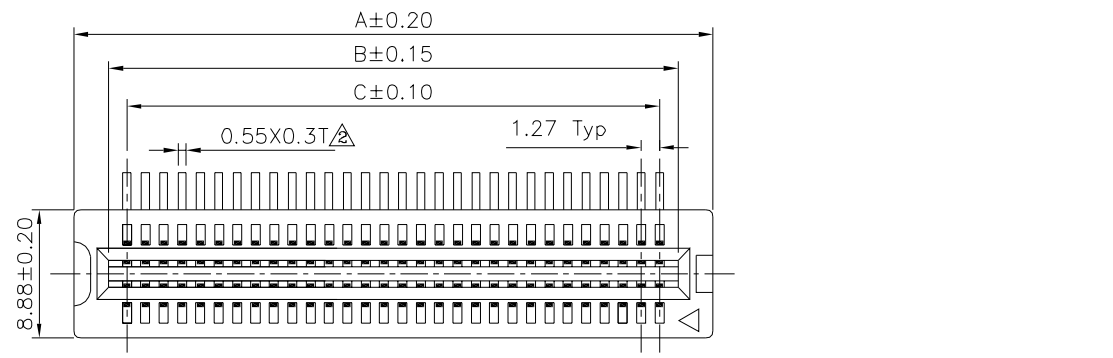

Pin	A	B	C	Pin	A	B	C
04	8.64	3.81	1.27	32	26.42	21.59	19.05
06	9.91	5.08	2.54	34	27.69	22.86	20.32
08	11.18	6.35	3.81	36	28.96	24.13	21.59
*10	12.45	7.62	5.08	38	30.23	25.40	22.86
12	13.72	8.89	6.35	42	32.77	27.94	25.40
14	14.99	10.16	7.62	44	34.04	29.21	26.67
16	16.26	11.43	8.89	46	35.31	30.48	27.94
18	17.53	12.70	10.16	48	36.58	31.75	29.21
*20	18.80	13.97	11.43	52	39.12	34.29	31.75
*22	20.07	15.24	12.70	54	40.39	35.56	33.02
*24	21.34	16.51	13.97	56	41.66	36.83	34.29
26	22.61	17.78	15.24	58	42.93	38.10	35.56
28	23.88	19.05	16.51	100	69.60	64.77	62.23
*30	25.15	20.32	17.78	*120	82.30	77.47	74.93

The Mark Of "*" Are Tooled Ready

4UCON 元化興業股份有限公司
 4UCON TECHNOLOGY INC.

DRAWING No. 01813
 SCALE NONE

APPROVED BY MEI
 CHECKED BY HZF
 DRAWING BY CYP
 REV. B4

UNLESS OTHERWISE SPECIFIED TOLERANCES ARE
 X. ±0.20
 .X ±0.15
 .XX ±0.10
 .XXX ±0.05

NO.	REV.	REVISIONS	CHK	DATE
△ B4		Modify Data	HZF	09/23/2022
△ B3		Modify Data	HZF	01/30/2019
△ B2		Modify Data	HZF	01/17/2019
△ B1		Modify Data	HZF	11/07/2015
△ B0		NEW RELEASE	HZF	09/08/2014

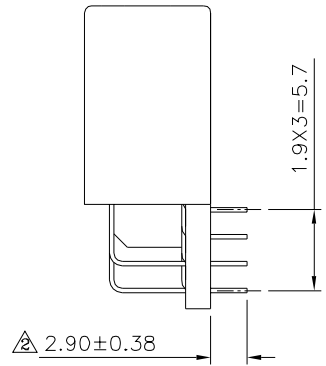
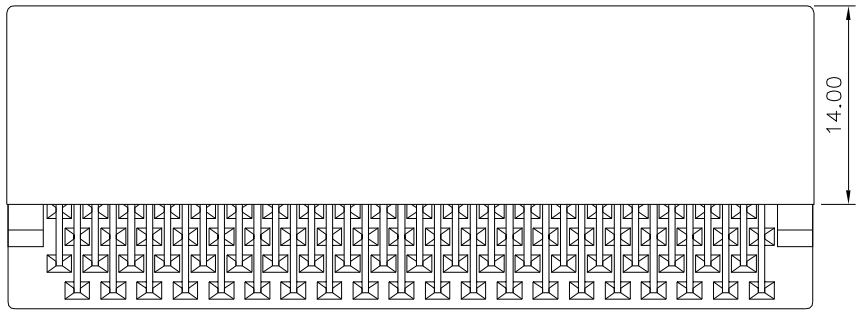
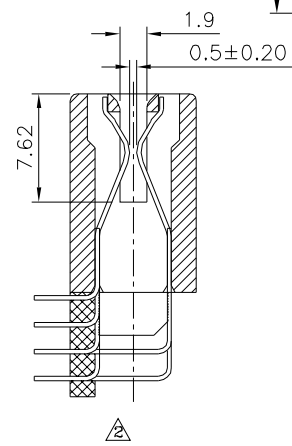
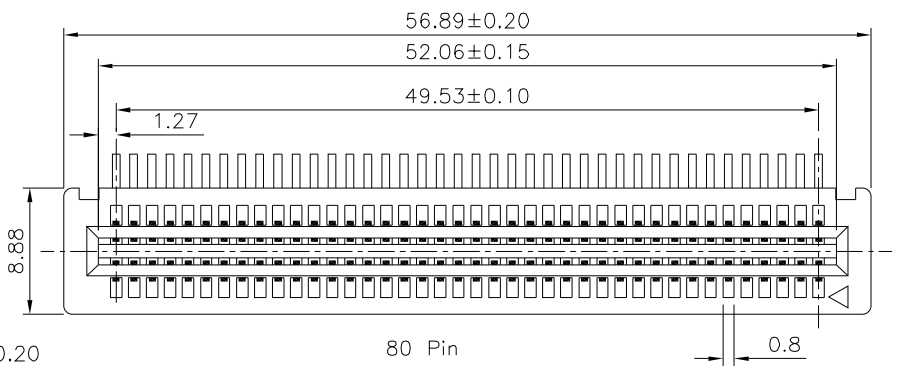
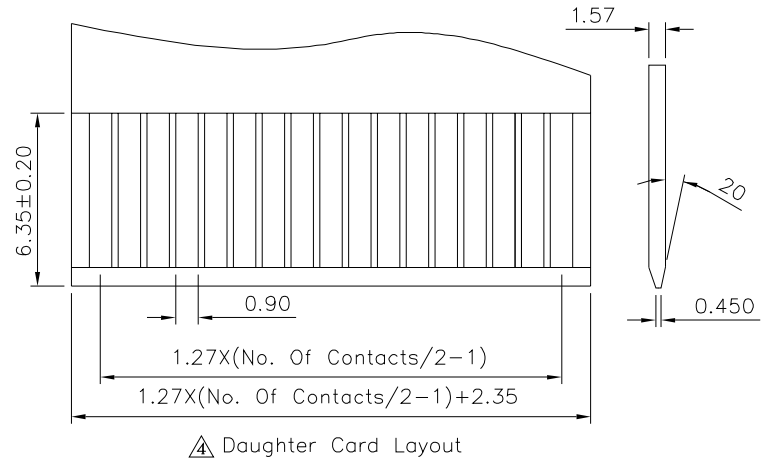
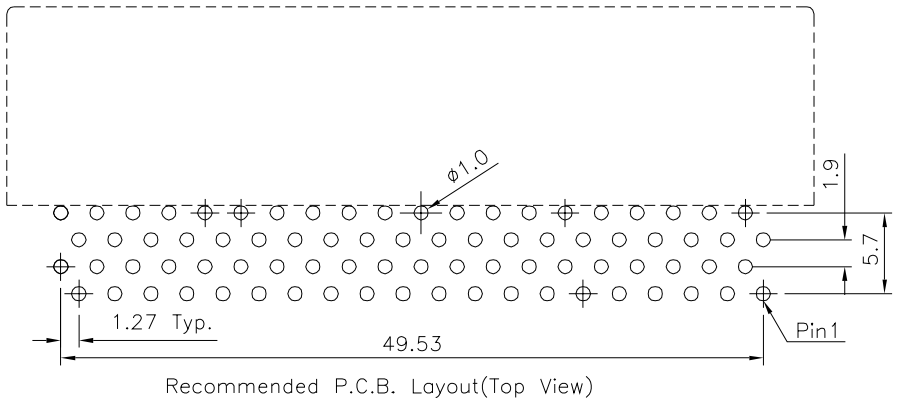

4UCON 元化興業股份有限公司
4UCON TECHNOLOGY INC.

DRAWING No. 01813

APPROVED BY MEI
CHECKED BY HZF
DRAWING BY CYP

UNLESS OTHERWISE SPECIFIED TOLERANCES ARE
0~10 ±0.20
10~30 ±0.30
30~100 ±0.40
100~300 ±0.50
ANG. ±0.5°

NO.	REV.	REVISIONS	CHK	DATE
△4	B4	Modify Data	HZF	09/23/2022
△3	B3	Modify Data	HZF	01/30/2019
△2	B2	Modify Data	HZF	01/17/2019
△1	B1	Modify Data	HZF	11/07/2015
△0	B0	NEW RELEASE	HZF	09/08/2014

SCALE NONE REV. B4 UNIT mm

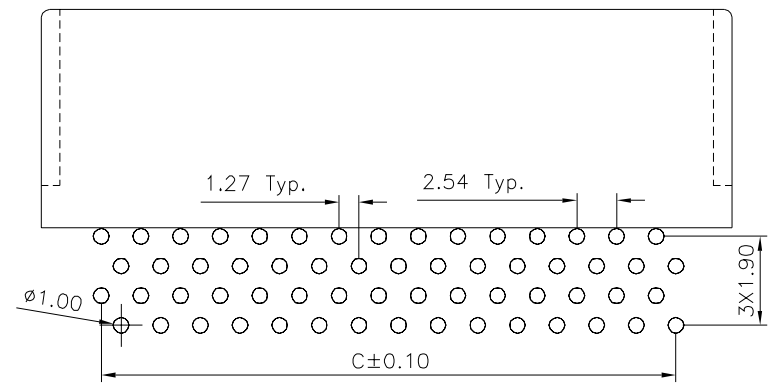
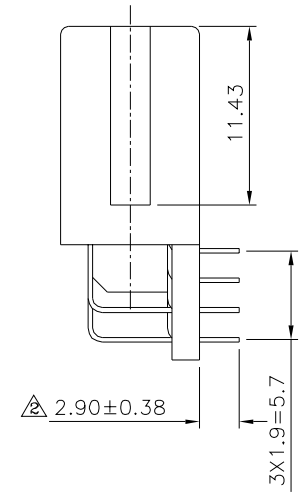
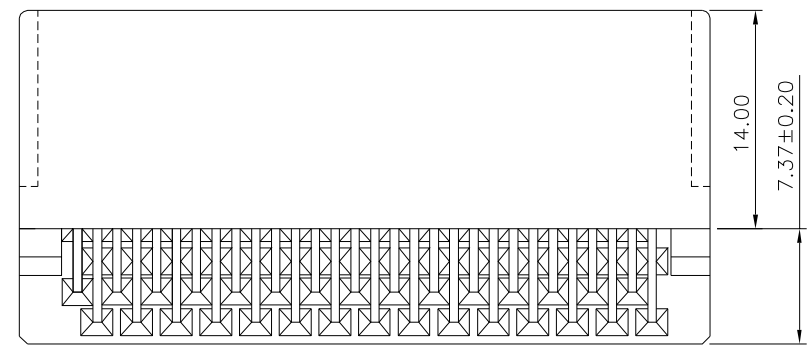
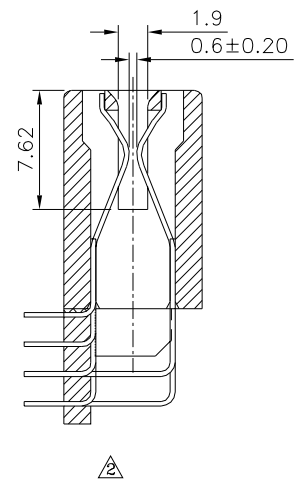
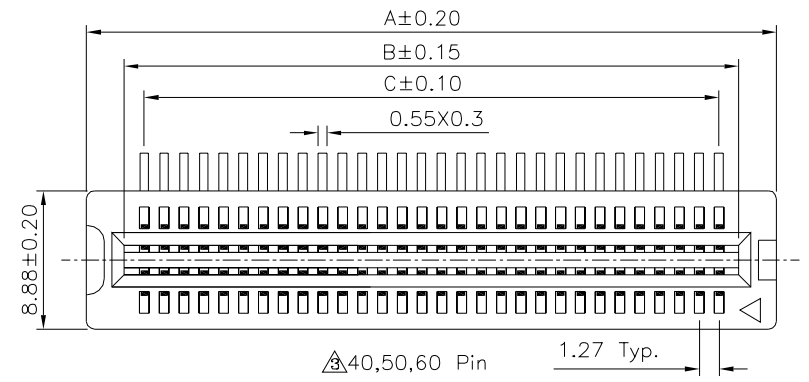

Pin	A	B	C
40	31.50	26.67	24.13
50	37.85	33.02	30.48
60	44.20	39.37	36.83

4UCON 元化興業股份有限公司
4UCON TECHNOLOGY INC.

DRAWING No.		APPROVED BY		UNLESS OTHERWISE SPECIFIED TOLERANCES ARE .X ±0.20 .XX ±0.15 .XX ±0.10 .XXX ±0.05	△ B4	Modify Data	HZF	09/23/2022	
01813		MEI			△ B3	Modify Data	HZF	01/30/2019	
		CHECKED BY			△ B2	Modify Data	HZF	01/17/2019	
		HZF		△ B1	Modify Data	HZF	11/07/2015		
		DRAWING BY		△ B0	NEW RELEASE	HZF	09/08/2014		
SCALE	NONE	REV.	B4	UNIT	mm	NO. REV.	REVISIONS	CHK	DATE