

△ 1X02

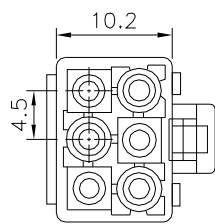

△ 2X03

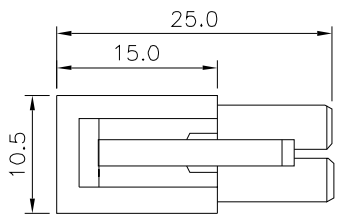
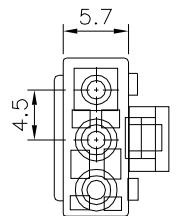
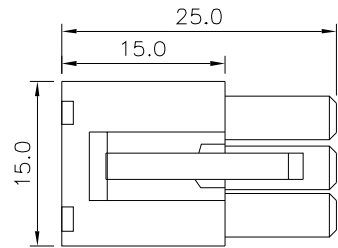

△ 1X03

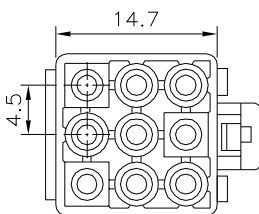

△ 3X03

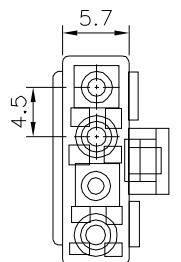
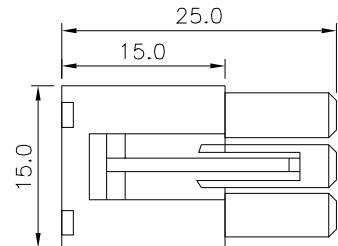

△ 1X04

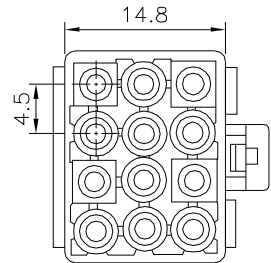
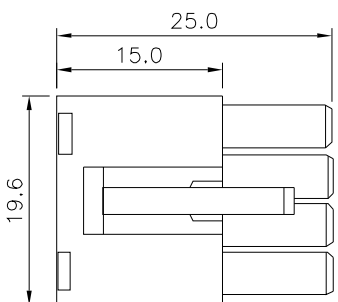

△ 3X04

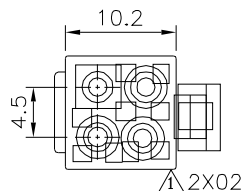
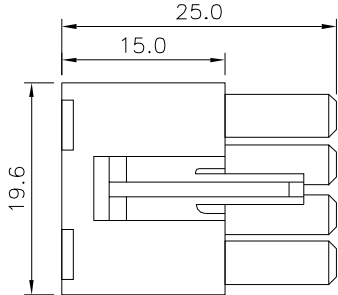

△ 2X02

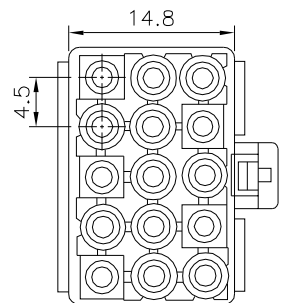
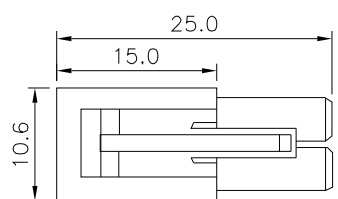

△ 3X05

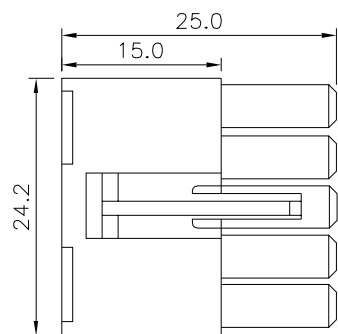

△ SPECIFICATION
 Current Rating: 7A AC/DC
 Voltage Rating: 300V AC/DC
 Withstand Voltage: 1500V AC/Minute
 Insulation Resistance: 1000 Megaohms Min.
 Temperature Range: -25°C ~ +85°C
 Material: PA66(UL94V-0), White
 RoHS Compliant

4UCON 元化興業股份有限公司
 4UCON TECHNOLOGY INC.

DRAWING No. △△		APPROVED BY		UNLESS OTHERWISE SPECIFIED TOLERANCES ARE
02324		MEI	.X ±0.3	
		CHECKED BY		
SCALE		DRAWING BY		UNIT
NONE	REV.	SONG	mm	
		A4		

△4	A4	Modify Data	HZF	03/23/2021
△3	A3	Modify Data	HZF	08/05/2013
△2	A2	Modify Data	HZF	09/10/2010
△1	A1	Modify Data	HZF	01/28/2010
△0	A0	NEW RELEASE		
NO. REV.	REVISIONS		CHK	DATE