

△ SPECIFICATION
 △ Current Rating:5A AC/DC
 Voltage Rating:250V AC/DC
 Withstand Voltage:1500V AC/Minute
 Insulation Resistance:1000 Megaohms Min.
 Temperature Range:-25°C~+85°C
 Insulator:PA66(UL94V-2)
 RoHS Compliant

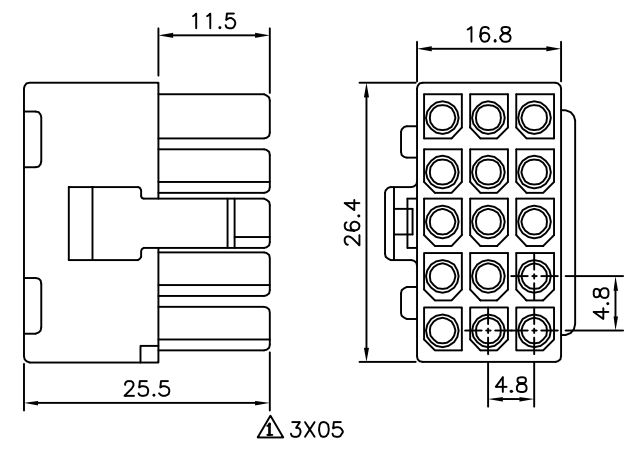
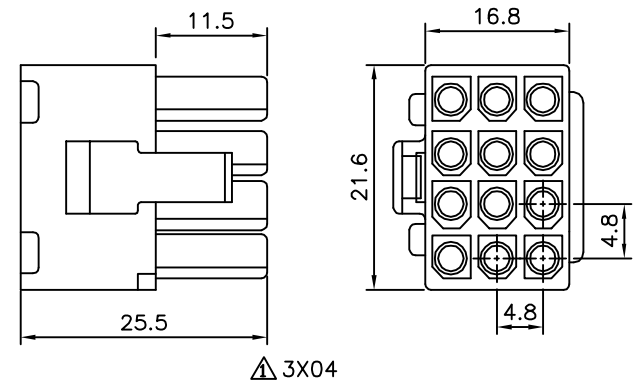
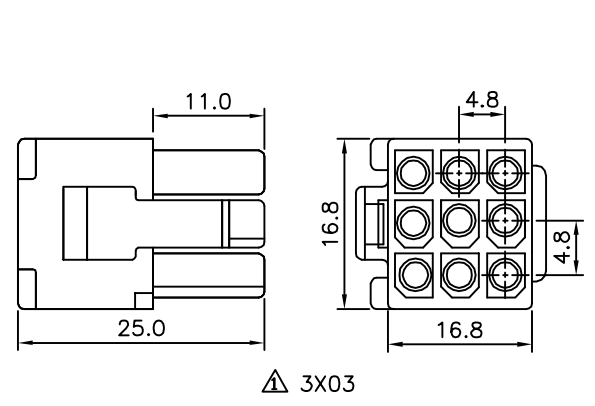
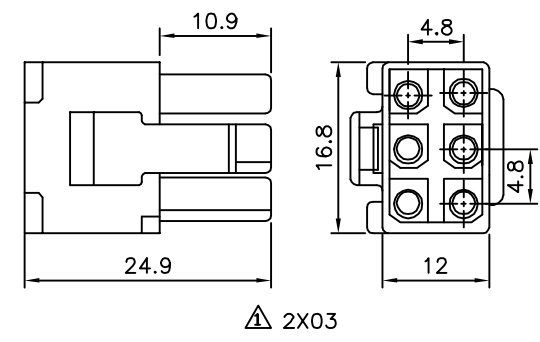
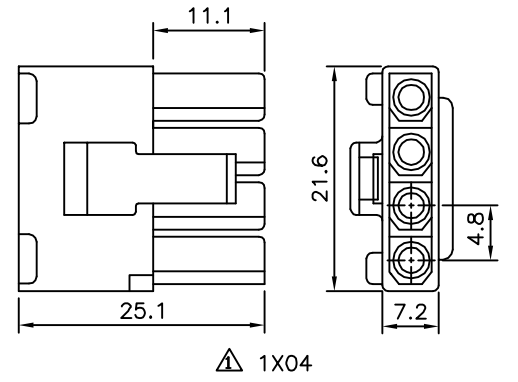
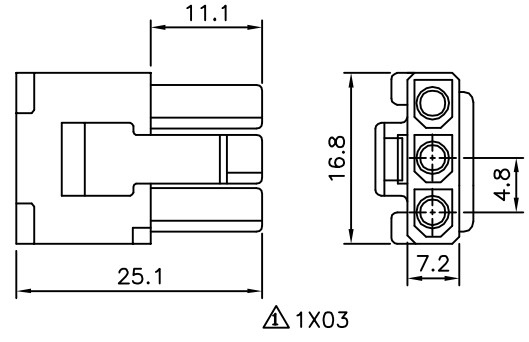
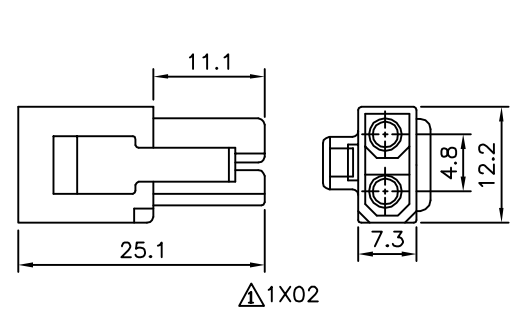

4UCON 元化興業股份有限公司
 4UCON TECHNOLOGY INC.

DRAWING No.		APPROVED BY		UNLESS OTHERWISE SPECIFIED TOLERANCES ARE X. ±0.3 .X ±0.3 △
02342		EMILY		
		CHECKED BY		
		HZF		
		DRAWING BY		UNIT mm
		SONG		
SCALE	NONE	REV.	A2	

NO.	REV.	REVISIONS	CHK	DATE
△ A2		Modify Spec.	HZF	03/29/2014
△ A1		Modify Data	HZF	07/05/2011
△ A0		NEW RELEASE		