

SPECIFICATIONS
Material: Zinc Alloy, Ni Plated

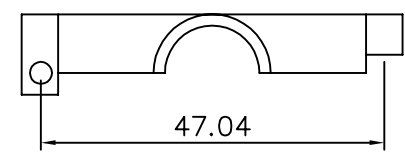
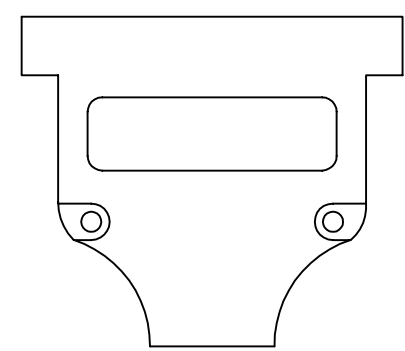
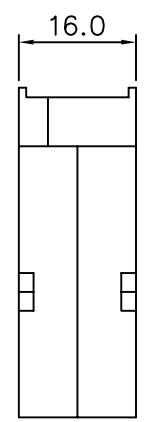
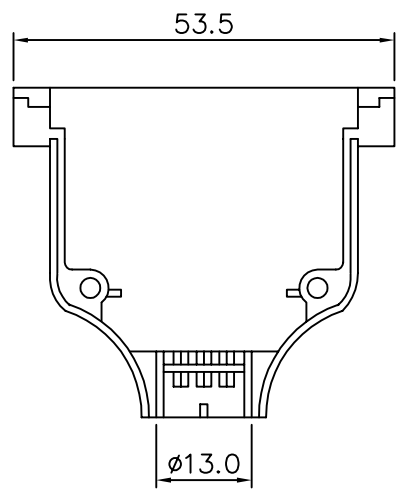

4UCON 元化興業股份有限公司
4UCON TECHNOLOGY INC.

DRAWING No. 02998		APPROVED BY MEI		UNLESS OTHERWISE SPECIFIED TOLERANCES ARE .X ±0.38 .XX ±0.25 ANG.			
		CHECKED BY RAN					
		DRAWING BY HZF					
SCALE NONE	REV. A	UNIT mm		AREA	REVISIONS	CHK	DATE