

SPECIFICATION

Current Rating: 3 Amp
 Voltage Rating: 250V AC/RMS 60Hz
 Dielectric Withstanding Voltage: 1000V AC/RMS 60 Hz For 1 Minute
 Contact Resistance: 20 Milliohms Max.
 Insulation Resistance: 1000 Megaohms Min. At 500V DC
 Insulator: PBT+G.F.(UL94V-0), Blue
 Contact: Brass
 Shell: Steel, Tin Plated Over Copper
 RoHS Compliant

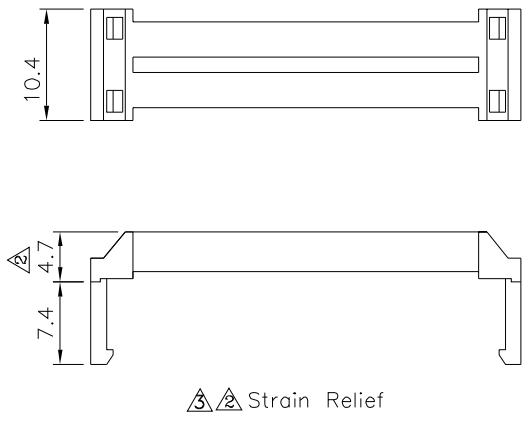
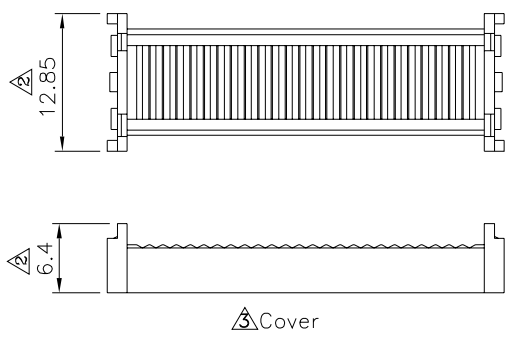
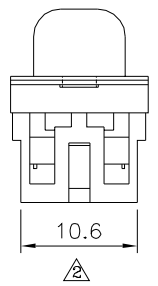
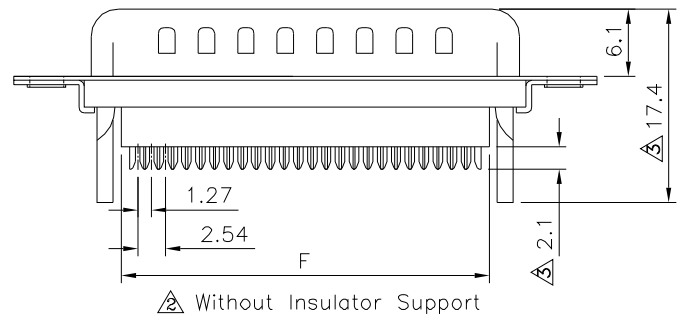

Pos.	A	B	C	E	F
09	30.81	24.99	16.92	11.08	13.10
15	39.20	33.30	25.25	19.39	20.70
25	53.04	47.04	38.96	33.24	33.68
37	69.40	63.50	55.42	49.86	50.30

4UCON 元化興業股份有限公司
 4UCON TECHNOLOGY INC.

DRAWING No. 03031

APPROVED BY MEI
 CHECKED BY HZF
 DRAWING BY HTP

UNLESS OTHERWISE SPECIFIED TOLERANCES ARE
 X. ± 0.38 X.* $\pm 3^\circ$
 .X ± 0.25 .X* $\pm 1.0^\circ$
 .XX ± 0.13

NO.	REV.	REVISIONS	CHK	DATE
A3		Modify Data	HZF	12/20/2022
A2		Modify Data	HZF	04/11/2012
A1		Modify Data	SHIN	02/26/2007
A0		NEW RELEASE		

SCALE NONE REV. A3

