

**SPECIFICATION**

⚠ Current Rating:3 Amp  
 Voltage Rating:250V AC/RMS 60Hz  
 Contact Resistance:20 Milliohms Max. At 1 Amp DC  
 Insulation Resistance:1000 Megaohms At 500V DC  
 Dielectric Withstanding Voltage:1000V AC/RMS 60Hz  
 For 1 Minute  
 ⚠ Insulator:PBT+G.F.(UL94V-0),Blue  
 Contact:Brass  
 Gold Flash On Contact Area,Tin  
 Plated On Solder Tails,Over Nickel  
 RoHS Compliant

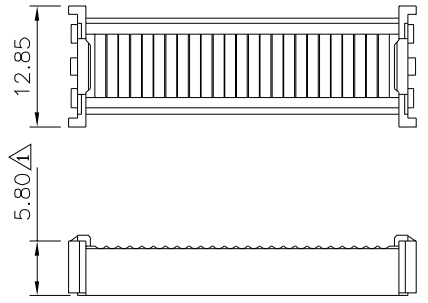

⚠ Cover

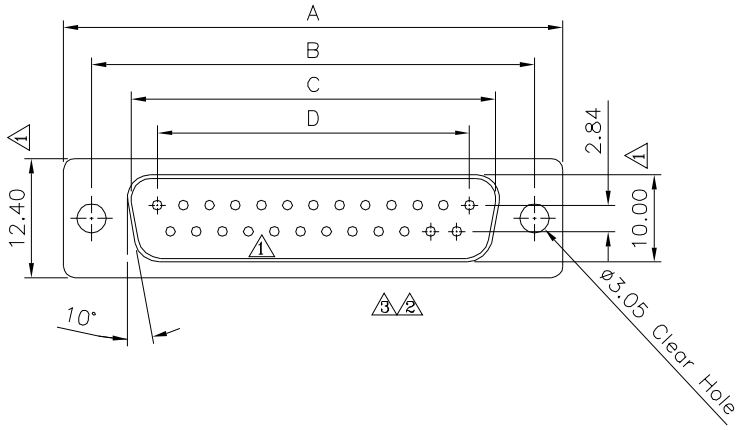
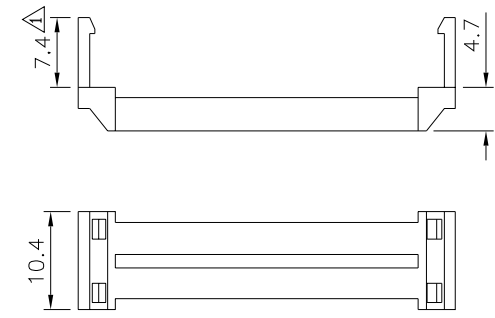
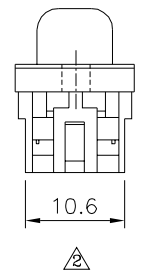
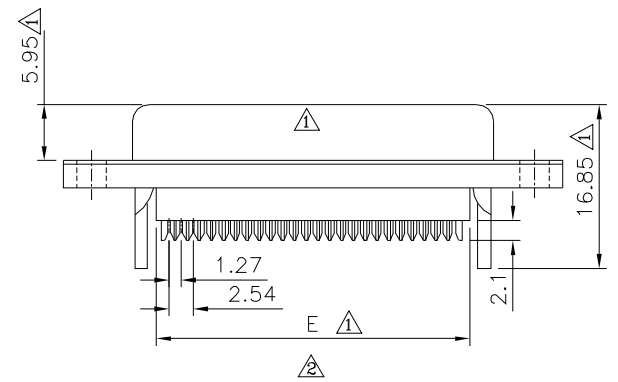

⚠ Strain Relief

Pin	A	B	C	D	E
09	30.50	25.00	18.05	11.08	13.10
15	39.00	33.32	26.35	19.39	20.70
25	53.08	47.04	40.95	33.24	33.68
37	69.25	63.50	55.60	49.86	50.30

**4UCON** 元化興業股份有限公司  
4UCON TECHNOLOGY INC.

DRAWING No.		APPROVED BY		UNLESS OTHERWISE SPECIFIED TOLERANCES ARE .X ±0.38 .X ±0.25 X' ±3° .XX ±0.13 .X' ±1.0°
03070		MEI		
		CHECKED BY	HZF	
		DRAWING BY	CYP	
SCALE	NONE	REV.	A3	UNIT mm

NO.	REV.	REVISIONS	CHK	DATE
⚠	A3	Modify Data	HZF	04/20/2015
⚠	A2	Modify Data	HZF	07/25/2012
⚠	A1	Modify Data	HZF	12/02/2008
⚠	A0	NEW RELEASE	HZF	08/20/2007