

SPECIFICATIONS

Current Rating: 5 AMP
 Dielectric Withstanding Voltage:
 1000V Per Minute
 Insulation Resistance: 1000 Megohms Min.
 At 500V DC
 Contact Resistance: 15 Milliohms Max. 10 SES.
 Operating Temperature: -55°C ~ +105°C
 Insulator: PBT+30% Glass Fiber
 UL 94V-0
 Contact: Brass, Tin Plated
 Shell: Steel Nickel Plated

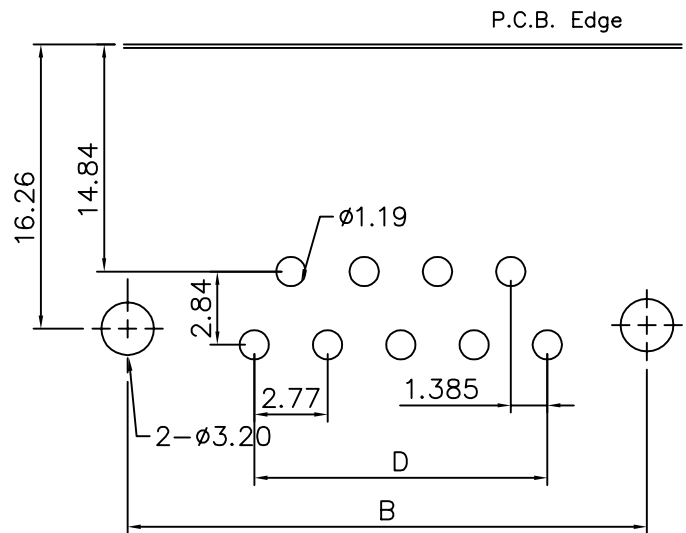

P.C.B. Layout

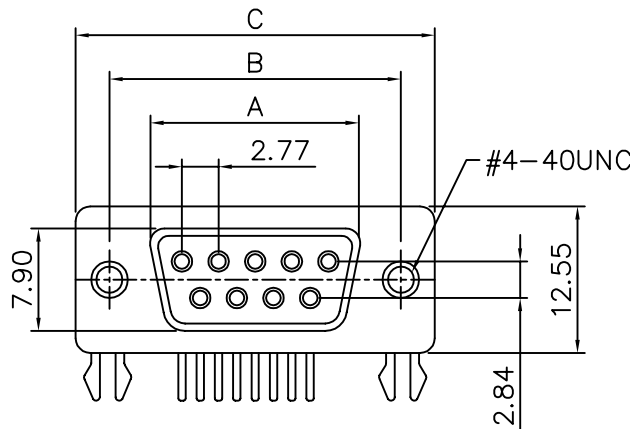
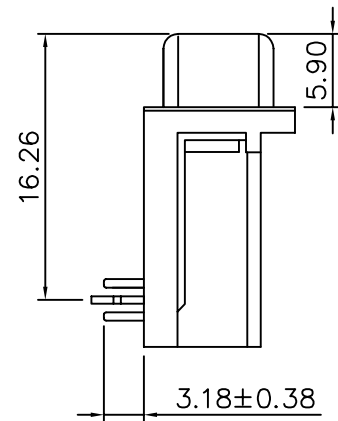
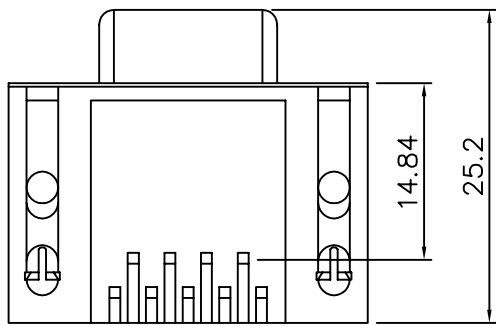

Pin	A±0.20	B±0.25	C±0.38	D
09	16.33	24.99	30.80	11.08
15	24.66	33.32	39.10	19.39
25	38.38	47.04	53.00	33.24
37	54.84	63.50	69.32	49.86

4UCON 元化興業股份有限公司
 4UCON TECHNOLOGY INC.

DRAWING No.
 03130

APPROVED BY MEI
 CHECKED BY RAN
 DRAWING BY HZF

UNLESS OTHERWISE SPECIFIED TOLERANCES ARE
 .X ±0.25
 .XX ±0.15
 .XXX ±0.05

SCALE NONE REV. A UNIT mm

AREA REVISIONS CHK DATE