

SPECIFICATION
 Insulator: ABS, UL 94HB
 Color & Finish See Table 1
 Screw Nut & Clip And Other: Steel
 Nickel Plated
 Packing: 1 Set/Bag
 RoHS Compliant

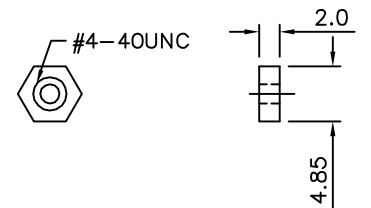
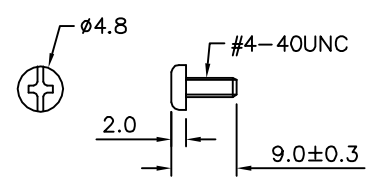
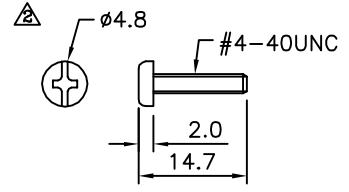
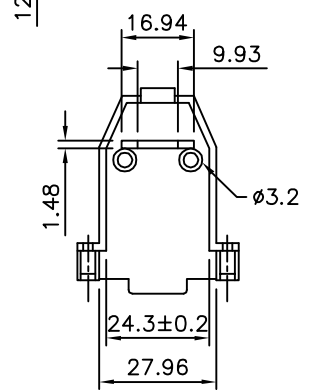
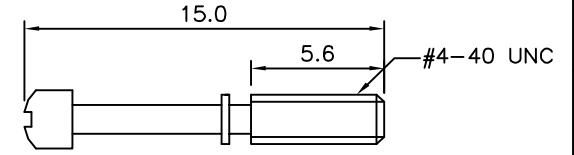
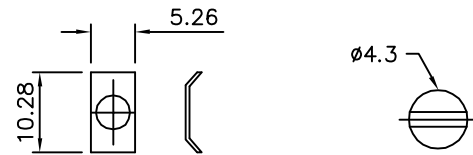
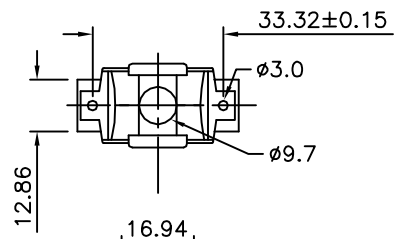

Table 1

Item No.	Color & Finish
03177	Chrome Plated
03169	Black
03161	Beige
03145	Grey

4UCON 元化興業股份有限公司
 4UCON TECHNOLOGY INC.

DRAWING No.		APPROVED BY		UNLESS OTHERWISE SPECIFIED TOLERANCES ARE .X ±0.38 .XX ±0.25 ANG.
03161		MEI		
		CHECKED BY HZF		
DRAWING BY		HYY		UNIT mm
SCALE	NONE	REV.	A2	

NO.	REV.	REVISIONS	CHK	DATE
△A2		Modify Data	HZF	02/12/2009
△A1		Modify Data	HZF	11/07/2008
△A0		NEW RELEASE	HZF	01/24/2008