

△ SPECIFICATION
 Insulator:ABS(UL94HB),Grey
 Screw,Nut&SR:Steel,Nickel Plated
 Packing:One Bag/Set
 RoHS Compliant

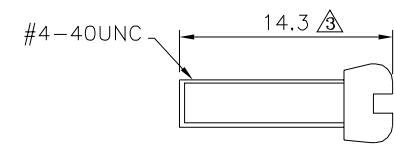
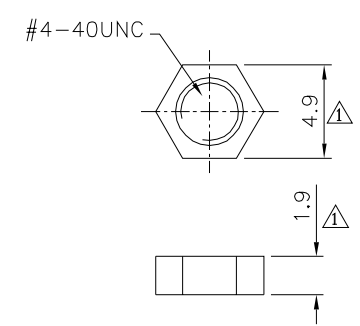
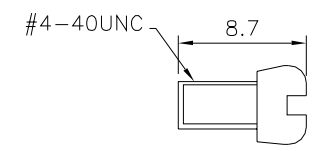
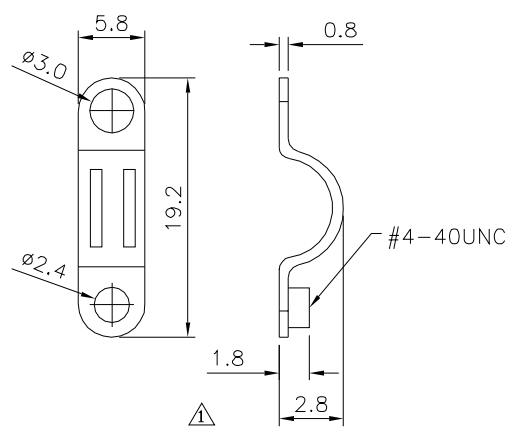
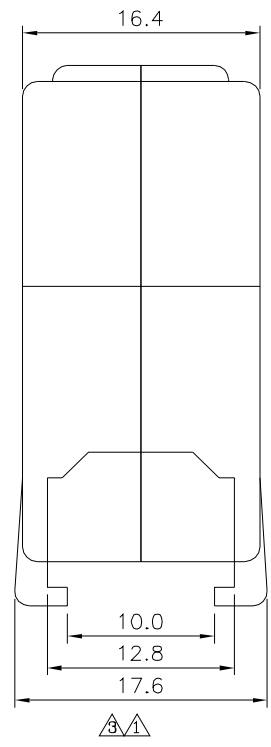
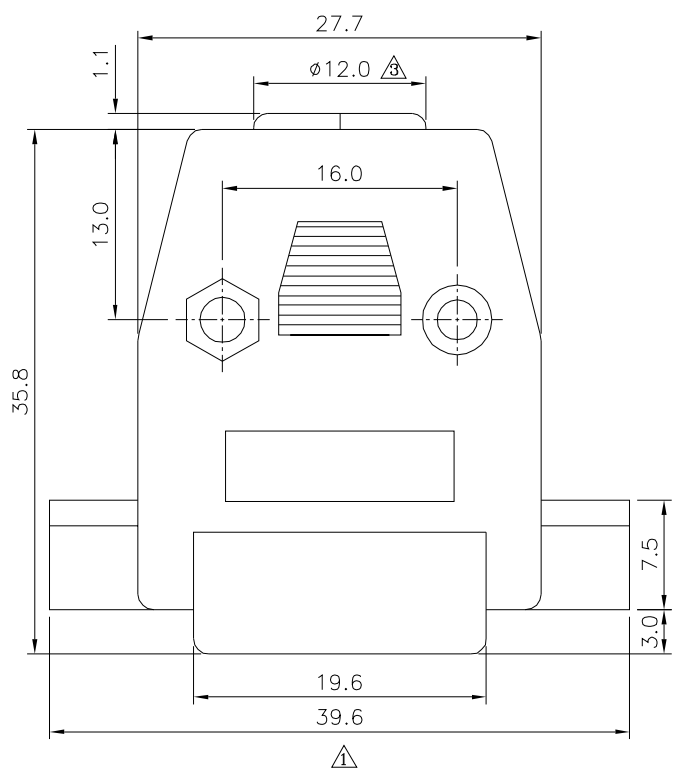

4UCON 元化興業股份有限公司
 4UCON TECHNOLOGY INC.

DRAWING No.		APPROVED BY		UNLESS OTHERWISE SPECIFIED TOLERANCES ARE △ X. ±0.6 △ .X ±0.5 △ .XX ±0.2 ANG. ±5°
03176		MEI		
		CHECKED BY	HZF	
		DRAWING BY	HAO	
SCALE	NONE	REV.	A3	UNIT mm

NO.	REV.	REVISIONS	CHK	DATE
△3	A3	Modify Data	HZF	12/07/2023
△2	A2	Modify Data	HZF	09/24/2014
△1	A1	Modify Data	HZF	03/14/2013
△0	A0	NEW RELEASE	HZF	05/07/2008