

SPECIFICATIONS
 Color:Black
 Packing:Bulk

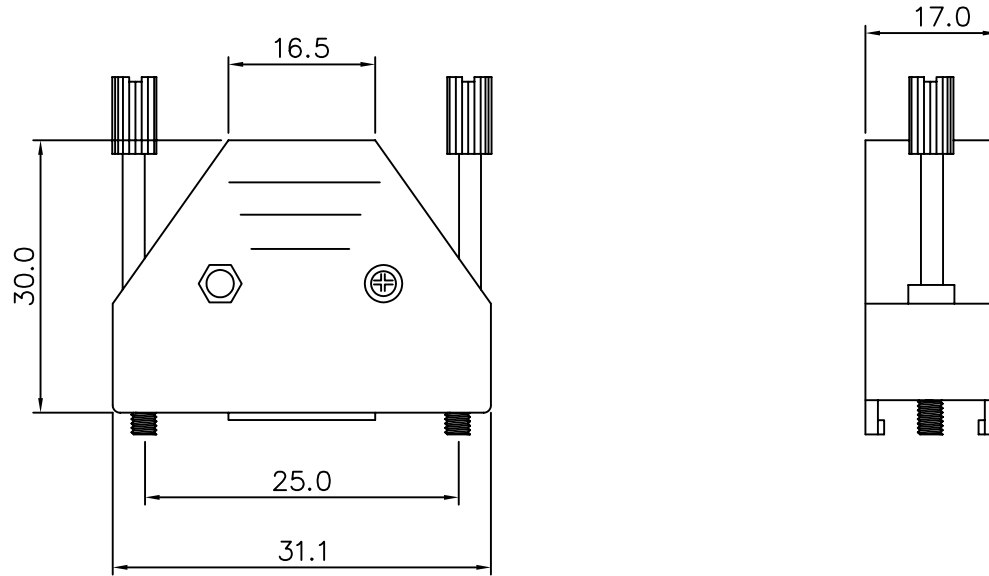

4UCON 元化興業股份有限公司
 4UCON TECHNOLOGY INC.

DRAWING No.
 03381

APPROVED BY
 MEI
 CHECKED BY
 RAN
 DRAWING BY
 HZF

UNLESS OTHERWISE SPECIFIED
 TOLERANCES ARE
 .X ±0.38
 .XX ±0.25
 AWG.

SCALE NONE

REV. A

UNIT mm

AREA	REVISIONS	CHK	DATE