

SPECIFICATION

- 1.General Characteristics:**
0.5mm FPC XXP SMT 90° ZIF Top Contact
- 2.Material&Finish:**
Insulator:PA9T,UL94V-0,Ivory
Slider:PPS,UL94V-0,Black
Terminal:Phosphor Bronze,Tin Plated Over Nickel
Me:Brass,Tin Plated Over Nickel
- 3.Electrical Characteristics:**
Operating Voltage:50V Max.
Current Rating:0.5 Amp Max.
Contact Resistance:20 Milliohms Max.
Insulation Resistance:50 Megaohms Min.
Dielectric Withstanding Voltage:250V AC RMS.
- 4.Environmental Characteristics:**
Operation Temperature:-20°C~+85°C
Processing Temperature:245°C±5°C For 30s
- 5.Other**
Accommodated FFC/FPC Thickness:0.30±0.03mm
- 6.RoHS Compliant**

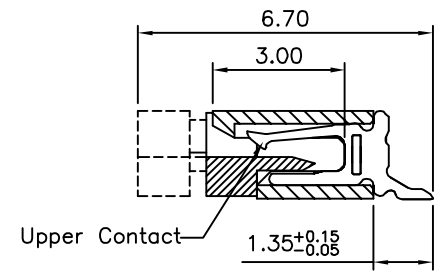
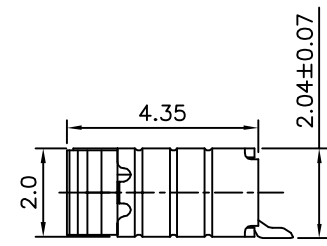
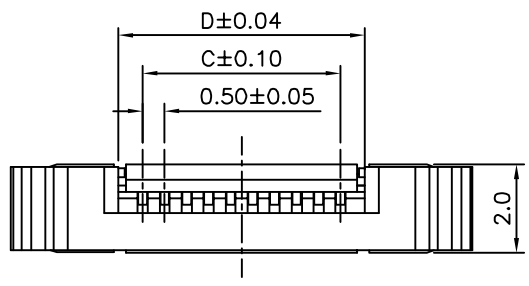
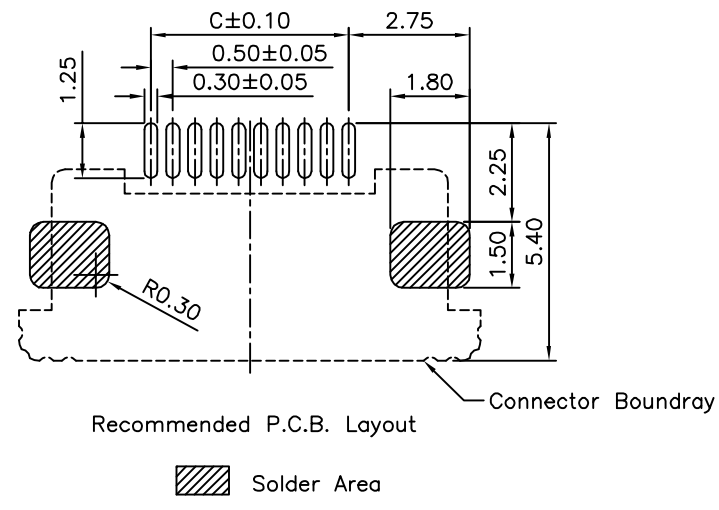
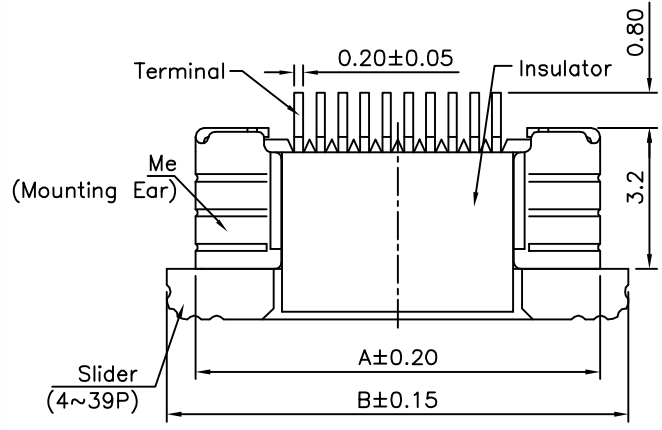

4UCON 元化興業股份有限公司
4UCON TECHNOLOGY INC.

DRAWING No.		APPROVED BY		UNLESS OTHERWISE SPECIFIED TOLERANCES ARE .X ±0.35 .XX ±0.20					
03939		MEI							
		CHECKED BY							
		HZF							
		DRAWING BY							
		SONG							
SCALE	NONE	REV.	BO	UNIT	mm	BO	NEW RELEASE	HZF	07/15/2013
						NO.REV.	REVISIONS	CHK	DATE

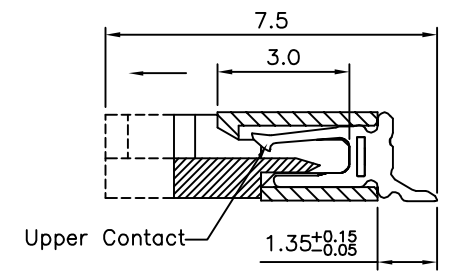
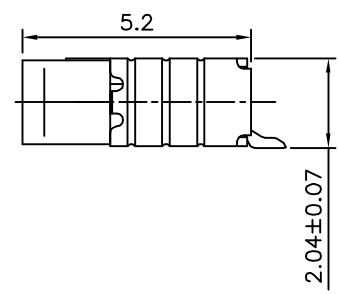
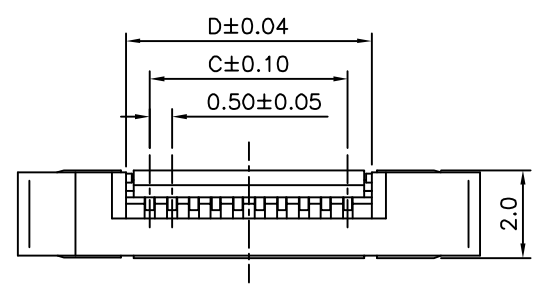
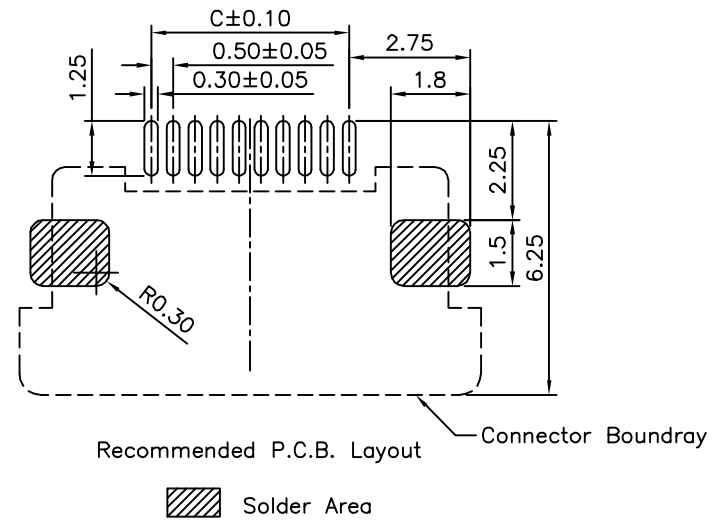
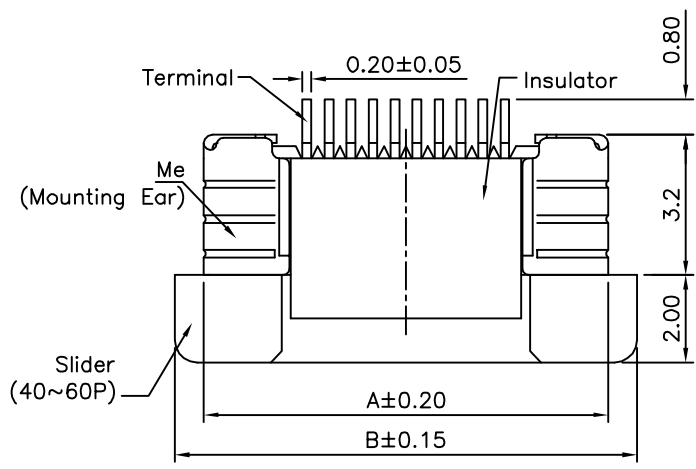

4UCON 元化興業股份有限公司
4UCON TECHNOLOGY INC.

DRAWING No.		APPROVED BY		UNLESS OTHERWISE SPECIFIED TOLERANCES ARE .X ±0.35 .XX ±0.20					
03939		MEI							
		CHECKED BY							
		HZF							
		DRAWING BY							
		SONG							
SCALE	NONE	REV.	BO	UNIT	mm	BO	NEW RELEASE	HZF	07/15/2013
						NO. REV.	REVISIONS	CHK	DATE

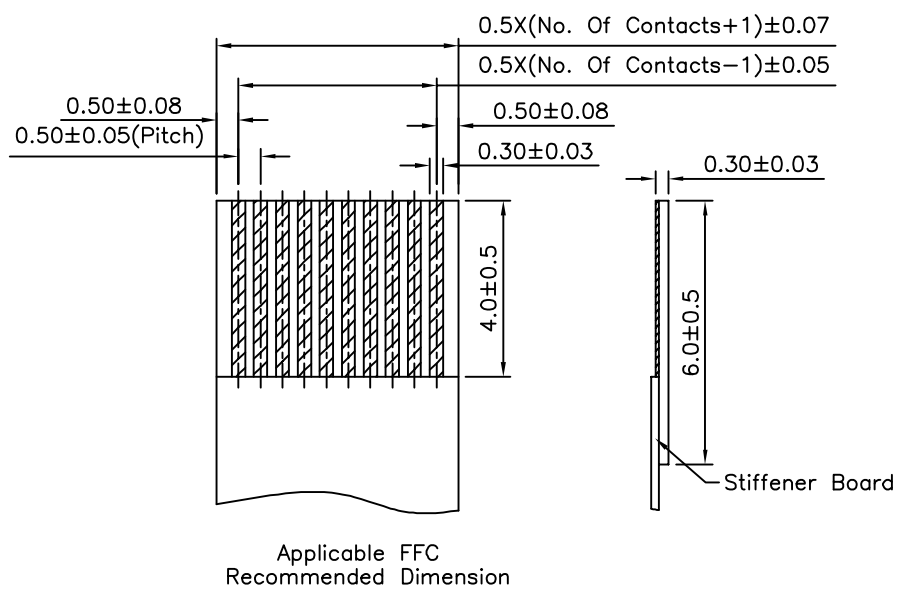
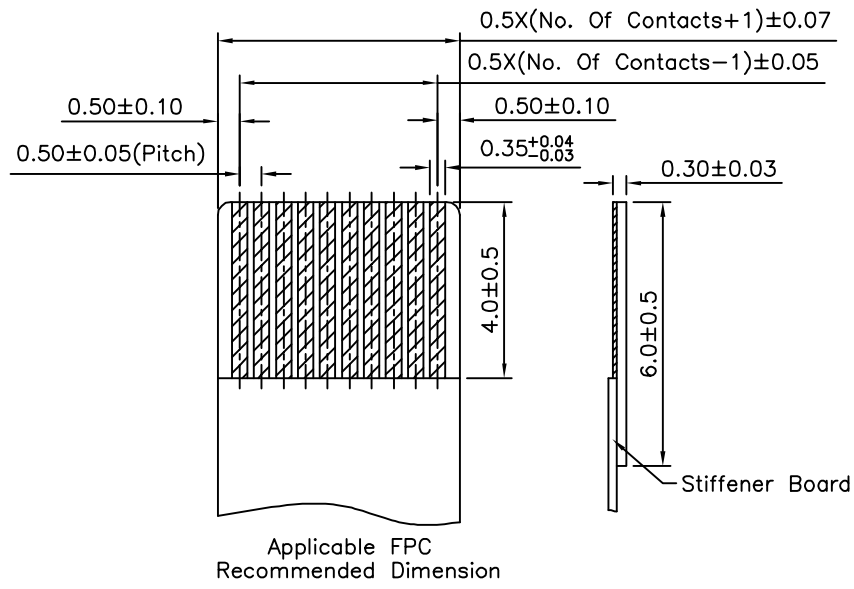

Pin	A	B	C	D
4	6.20	7.50	1.50	2.62
5	6.70	8.00	2.00	3.12
6	7.20	8.50	2.50	3.62
7	7.70	9.00	3.00	4.12
8	8.20	9.50	3.50	4.62
9	8.70	10.00	4.00	5.12
10	9.20	10.50	4.50	5.62
11	9.70	11.00	5.00	6.12
12	10.20	11.50	5.50	6.62
13	10.70	12.00	6.00	7.12
14	11.20	12.50	6.50	7.62
15	11.70	13.00	7.00	8.12
16	12.20	13.50	7.50	8.62
17	12.70	14.00	8.00	9.12
18	13.20	14.50	8.50	9.62
19	13.70	15.00	9.00	10.12
20	14.20	15.50	9.50	10.62
21	14.70	16.00	10.00	11.12
22	15.20	16.50	10.50	11.62
23	15.70	17.00	11.00	12.12
24	16.20	17.50	11.50	12.62
25	16.70	18.00	12.00	13.12
26	17.20	18.50	12.50	13.62
27	17.70	19.00	13.00	14.12
28	18.20	19.50	13.50	14.62
29	18.70	20.00	14.00	15.12
30	19.20	20.50	14.50	15.62
31	19.70	21.00	15.00	16.12
32	20.20	21.50	15.50	16.62
33	20.70	22.00	16.00	17.12
34	21.20	22.50	16.50	17.62
35	21.70	23.00	17.00	18.12
36	22.20	23.50	17.50	18.62
37	22.70	24.00	18.00	19.12
38	23.20	24.50	18.50	19.62
39	23.70	25.00	19.00	20.12
40	24.20	25.50	19.50	20.62
41	24.70	26.00	20.00	21.12
42	25.20	26.50	20.50	21.62
43	25.70	27.00	21.00	22.12
44	26.20	27.50	21.50	22.62
45	26.70	28.00	22.00	23.12
46	27.20	28.50	22.50	23.62
47	27.70	29.00	23.00	24.12
48	28.20	29.50	23.50	24.62
49	28.70	30.00	24.00	25.12
50	29.20	30.50	24.50	25.62
51	29.70	31.00	25.00	26.12
52	30.20	31.50	25.50	26.62
53	30.70	32.00	26.00	27.12
54	31.20	32.50	26.50	27.62
55	31.70	33.00	27.00	28.12
56	32.20	33.50	27.50	28.62
57	32.70	34.00	28.00	29.12
58	33.20	34.50	28.50	29.62
59	33.70	35.00	29.00	30.12
60	34.20	35.50	29.50	30.62

4UCON 元化興業股份有限公司
 4UCON TECHNOLOGY INC.

DRAWING No.		APPROVED BY		UNLESS OTHERWISE SPECIFIED TOLERANCES ARE .X ±0.35 .XX ±0.20
03939		MEI		
		CHECKED BY HZF		
		DRAWING BY SONG		
SCALE	NONE	REV.	BO	UNIT mm

△ BO	NEW RELEASE	HZF	07/15/2013
NO. REV.	REVISIONS	CHK	DATE