

SPECIFICATION

Current Rating:3A
 Dielectric Withstanding Voltage:1000V AC/Minute
 Contact Resistance:20 Milliohms Max.
 Insulation Resistance:5000 Megaohms Min. At 500V DC
 Operation Temperature:-55°C~+85°C
 Insertion Force:340g Max. Per Pair
 Withdrawal Force:28g Min. Per Pair
 Insulator:PBT+G.F.(UL94V-0)
 Contact:Brass,Gold Plated On Contact Area,
 Tin Plated On Solder Tails,Over Nickel
 RoHS Compliant

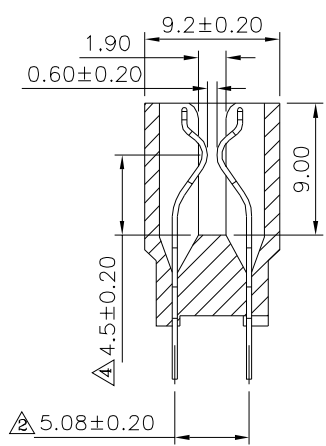
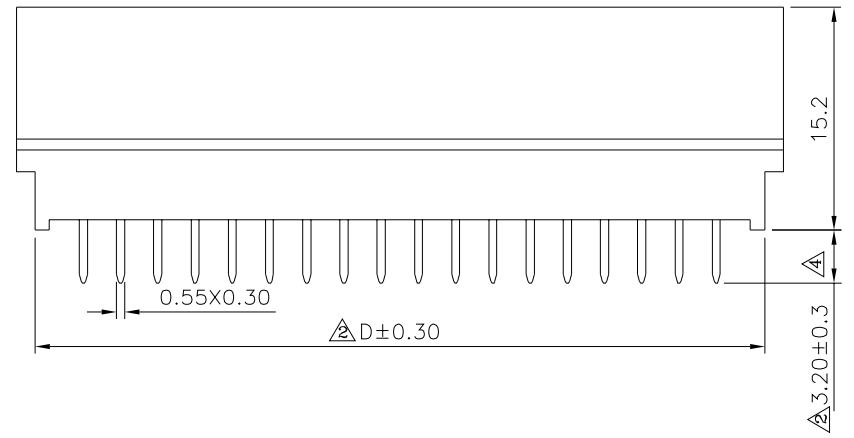
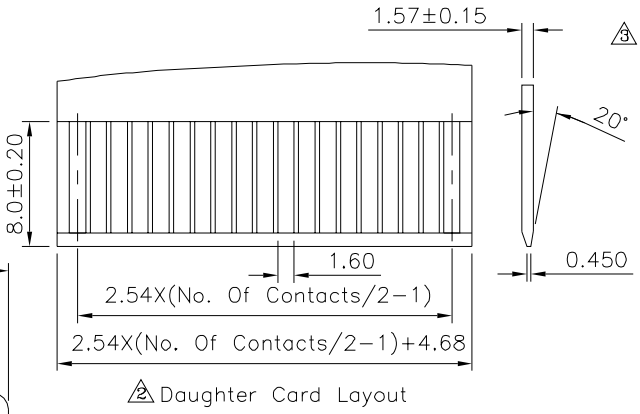
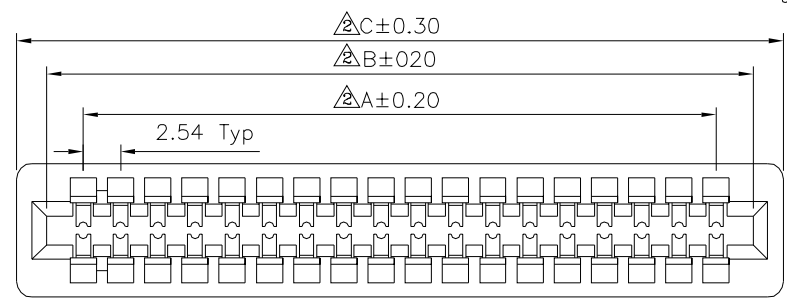

Pin	A	B	C	D	Pin	A	B	C	D
06	5.08	10.16	14.22	12.12	44	53.34	58.42	62.48	60.38
08	7.62	12.70	16.76	14.66	46	55.88	60.96	65.02	62.92
10	10.16	15.24	19.30	17.20	48	58.42	63.50	67.56	65.46
12	12.70	17.78	21.84	19.74	50	60.96	66.04	70.10	68.00
14	15.24	20.32	24.38	22.28	52	63.50	68.58	72.64	70.54
16	17.78	22.86	26.92	24.82	54	66.04	71.12	75.18	73.08
18	20.32	25.40	29.46	27.36	56	68.58	73.66	77.72	75.62
20	22.86	27.94	32.00	29.90	58	71.12	76.20	80.26	78.16
22	25.40	30.48	34.54	32.44	60	73.66	78.74	82.80	80.70
24	27.94	33.02	37.08	34.98	62	76.20	81.28	85.34	83.34
26	30.48	35.56	39.62	37.52	64	78.74	83.82	87.88	85.78
28	33.02	38.10	42.16	40.06	66	81.28	86.36	90.42	88.32
30	35.56	40.64	44.70	42.60	68	83.82	88.90	92.96	90.86
32	38.10	43.18	47.24	45.14	70	86.36	91.44	95.50	93.40
34	40.64	45.72	49.78	47.68	72	88.90	93.98	98.04	95.94
36	43.18	48.26	52.32	50.22	80	99.06	104.14	108.20	106.10
38	45.72	50.80	54.86	52.76	86	106.68	111.76	115.82	113.72
40	48.26	53.34	57.40	55.30	92	114.30	119.38	123.44	121.34
42	50.80	55.88	59.94	57.84	98	121.92	127.00	131.06	128.96
					100	124.46	129.54	133.60	131.50

4UCON 元化興業股份有限公司
 4UCON TECHNOLOGY INC.

DRAWING No.		APPROVED BY		UNLESS OTHERWISE SPECIFIED TOLERANCES ARE .X ±0.38 .XX ±0.25 ANG.	A4 Modify Data A3 Modify Data A2 Modify Data A1 Modify Data A0 NEW RELEASE	HZF	06/13/2020		
04590		MEI							
		HAO							
SCALE	NONE	REV.	A4	UNIT	mm	NO.REV.	REVISIONS	CHK	DATE