

Recommended P.C.B. Layout

△△△ SPECIFICATION
 Current Rating:3 Amp
 Voltage Rating:800V AC 1 Minute
 Contact Resistance:20 Milliohms Max.
 Insulation Resistance:5000 Megaohms Min.
 Operation Temperature:-55°C~+105°C
 Insertion Force:412 Grams Max. Per Pair
 Withdrawal Force:32 Grams Min. Per Pair
 Insulator:PBT+G.F.(UL94V-0),Black
 Contact:Phosphor Bronze,Gold Plated On Contact Area,Tin
 Plated On Solder Tails,Over Nickel
 RoHS Compliant

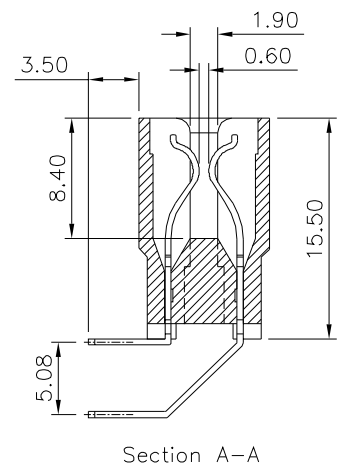
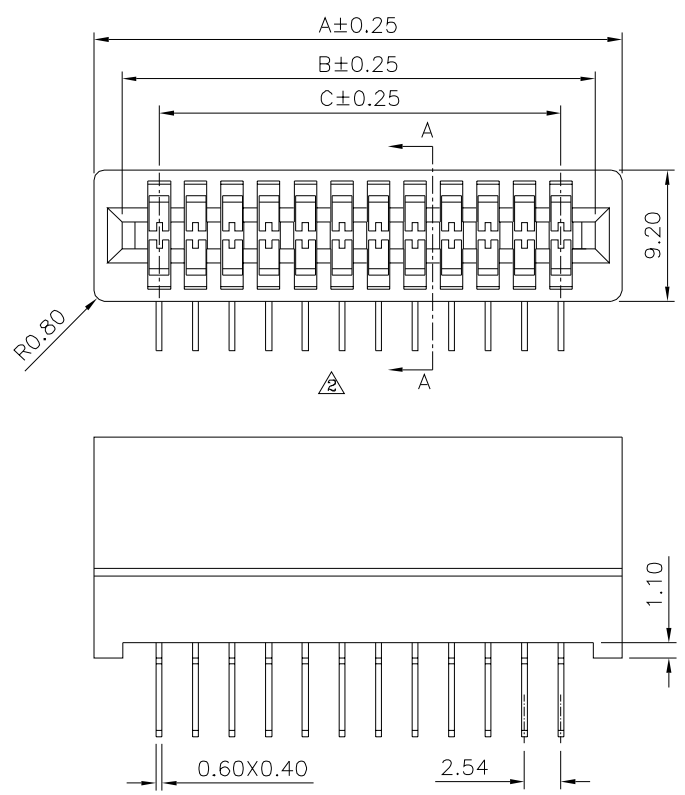

△△△

Pin	A	B	C	Pin	A	B	C
04	11.68	7.82	2.54	36	52.32	48.46	43.18
06	14.22	10.36	5.08	38	54.86	51.00	45.72
08	16.76	12.90	7.62	40	57.40	53.54	48.26
10	19.30	15.44	10.16	44	62.48	58.62	53.34
12	21.84	17.98	12.70	48	67.56	63.70	58.42
14	24.38	20.52	15.24	50	70.10	66.24	60.96
16	26.92	23.06	17.78	60	82.80	78.94	73.66
18	29.46	25.60	20.32	62	85.34	81.48	76.20
20	32.00	28.14	22.86	64	87.88	84.02	78.74
22	34.54	30.68	25.40	70	95.50	91.64	86.36
24	37.08	33.22	27.94	72	98.04	94.18	88.90
26	39.62	35.76	30.48	80	108.20	104.34	99.06
28	42.16	38.30	33.02	86	115.82	111.96	106.68
30	44.70	40.84	35.56	98	138.68	134.82	129.54
32	47.24	43.38	38.10	100	133.60	129.74	124.46
34	49.78	45.92	40.64	108	143.76	139.90	134.62

4UCON 元化興業股份有限公司
 4UCON TECHNOLOGY INC.

DRAWING No.		APPROVED BY		UNLESS OTHERWISE SPECIFIED TOLERANCES ARE △△△ X. ±0.50 △△△ .X ±0.38 △△△ .XX ±0.25	△ A4	Modify Data	HZF	08/04/2023
04609		MEI			△ A3	Modify Data	HZF	08/31/2018
		CHECKED BY			△ A2	Modify Data	HZF	07/25/2012
		HZF		△ A1	Modify Data	HZF	11/25/2009	
		DRAWING BY		△ A0	NEW RELEASE	HZF	07/11/2006	
		CYP		NO. REV.	REVISIONS	CHK	DATE	
SCALE	NONE	REV.	A4	UNIT	mm			