

SPECIFICATION

Housing:PBT+G.F.(UL94V-0),Black
 Contact:Phosphor Bronze \varnothing 0.45mm
 Gold Flash Over All,Over Nickel
 Cavity Confirms To FCC Rules And
 Regulations Part 68,Subpart F.
 RoHS Compliant

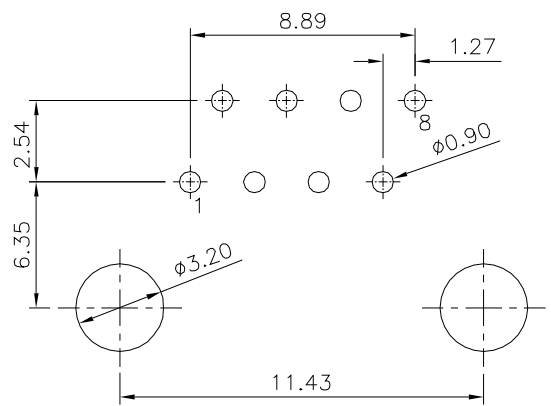

Recommended P.C.B. Layout

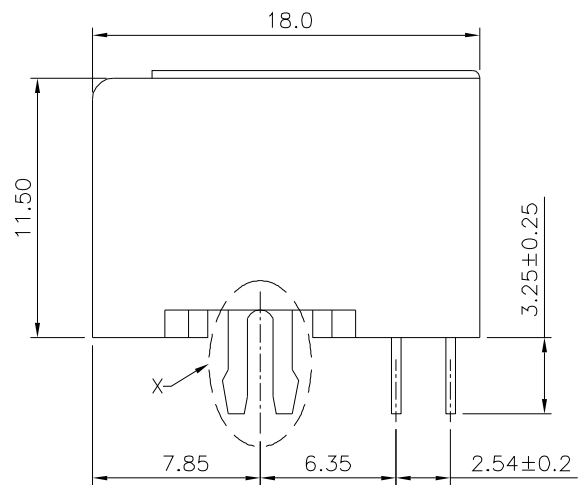
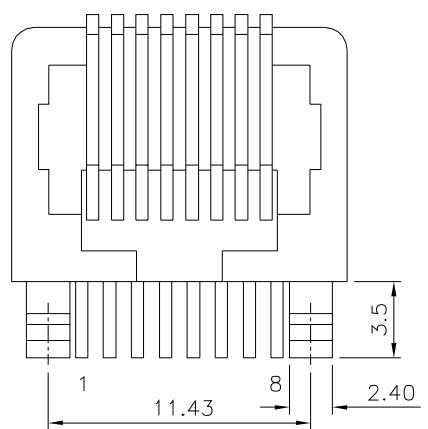
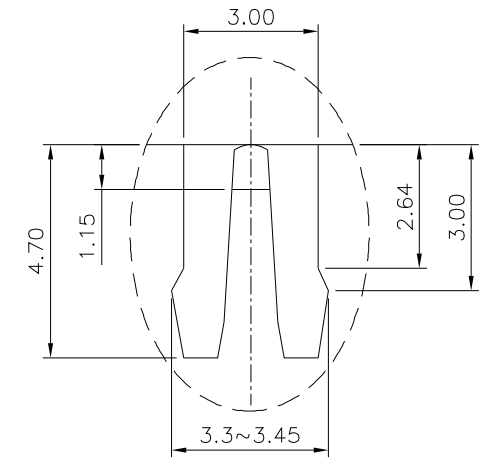
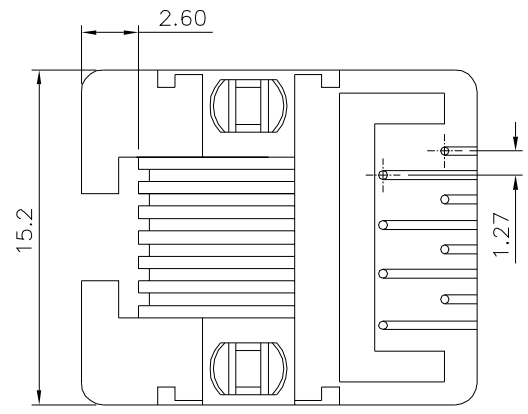

Detail X

4UCON 元化興業股份有限公司
 4UCON TECHNOLOGY INC.

DRAWING No.		APPROVED BY		UNLESS OTHERWISE SPECIFIED TOLERANCES ARE .X ±0.25 .XX ±0.13 .XXX ±0.05 ANG. ±0.5°
04894		MEI		
		HZF		
		DRAWING BY		UNIT mm
		HAO		
SCALE	NONE	REV.	B0	

NO.	REV.	REVISIONS	CHK	DATE
△ B0		NEW RELEASE	HZF	02/17/2023